

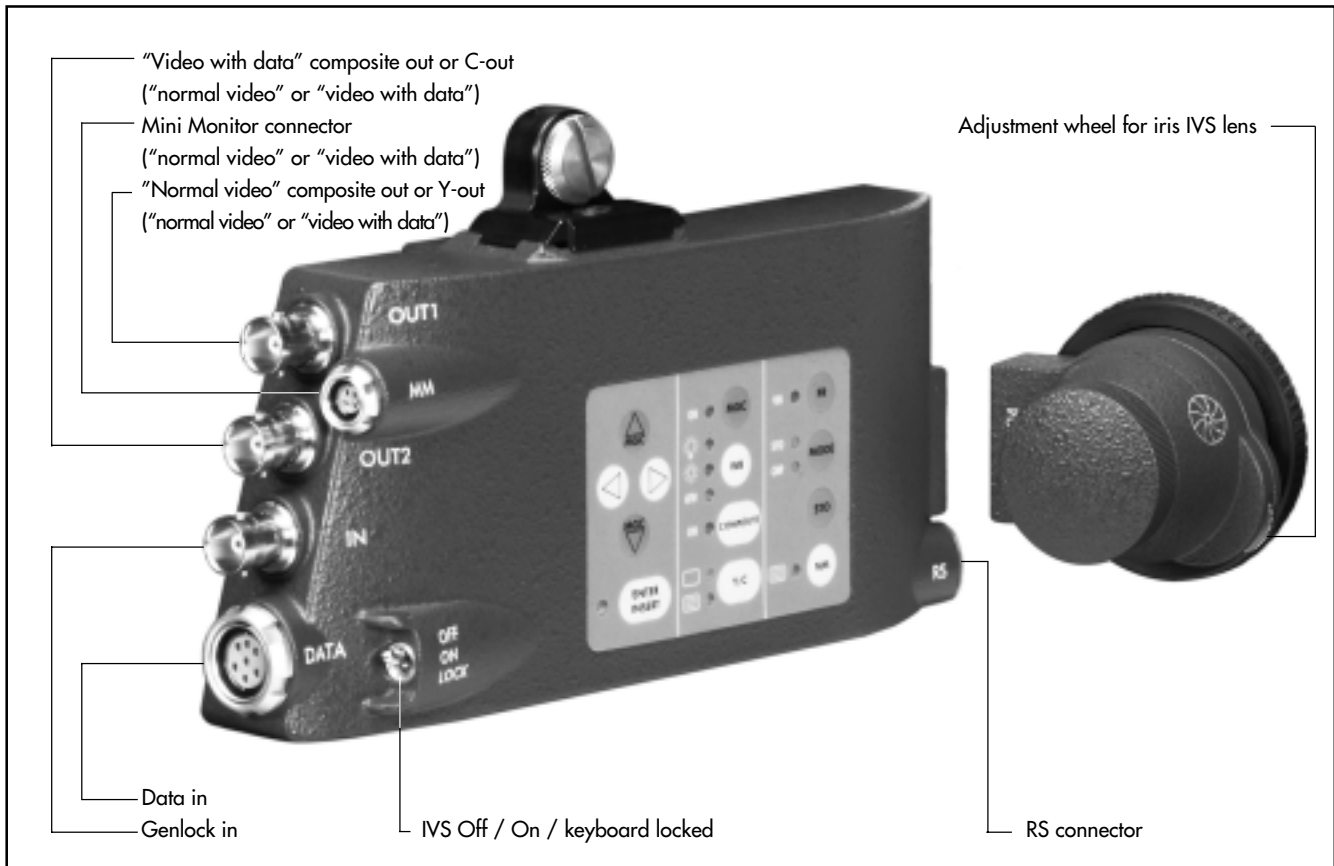

IVS

Instruction Manual  
Integrated Video Assist System for the ARRIFLEX 535B

As of: July 1999



# 1 Contents

<b>1</b>	<b>Contents</b> .....	3	<b>6</b>	<b>Inserter Facilities</b> .....	41
<b>2</b>	<b>Safety Specifications</b> .....	5	6.1	Setting the On Screen Displays .....	42
<b>3</b>	<b>General Description of the IVS</b> .....	7	6.2	Main Menu .....	44
3.1	Main Features .....	7	6.3	Format Markings Menu .....	45
3.2	System Components .....	9	6.4	Status Menu .....	51
<b>4</b>	<b>Setup</b> .....	13	6.5	Time Code Menu .....	61
4.1	Inserting the Optic .....	13	6.6	USER BITS Menu .....	67
4.2	Mounting the IVS on the camera .....	15	6.7	Text Menu .....	71
<b>5</b>	<b>Standard Video Controls</b> .....	31	6.8	Pull-Down Menu .....	75
5.1	Off/ On and Locking the Keyboard .....	31	6.9	Display Menu .....	81
5.2	Mechanical Iris .....	32	6.10	VITC Line Menu .....	87
5.3	Aligning the Image and Focusing .....	33	6.11	White Line Menu .....	91
5.4	White Balance (WB) .....	35	<b>7</b>	<b>Technical Data</b> .....	96
5.5	Gain Control .....	36	<b>8</b>	<b>Order Numbers</b> .....	96
5.6	Frame Store and Compare .....	37	<b>9</b>	<b>Index</b> .....	97
5.7	Switching between Composite Video and Y/C ...	38	<b>ARRI Service</b> .....	107	
5.8	Flicker free on/off .....	39			

Increase gain or  
cursor up or  
move inserted windows up or  
increase value IVS film counter active digit

Go to sub menu or  
move position of inserted windows right or  
increase inserter values or  
move IVS film counter active digit right

Go to sub menu or  
move position of inserted windows left or  
reduce inserter values or  
move IVS film counter active digit left

Reduce gain or  
cursor down or  
move inserted window down or  
reduce value IVS film counter active digit

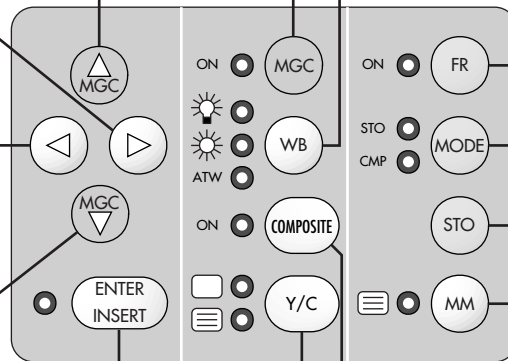

Activate inserter onscreen menu or  
store position of inserted window or  
store IVS film counter value

Manual Gain Control (ON)

White Balance  
(Indoor / Outdoor / Automatic)

Flickerfree (ON)

Mode (Framestore / Compare)

Store Key

"Normal video" or  
"video with data" at mini monitor output

Composite video or Y/C video

"Normal video" or  
"video with data" at Y/C output

## 2 Safety Specifications

### Warnings

Note: Operational error possible!



*Danger of injury  
or equipment damage possible!*

### General Safety Specifications



*Attention! Danger of injury!  
Never place your hand in the lens mount  
receptacle or the inside of the camera or  
magazine while it is running.*



*The control panel of the IVS must not be operated  
using hard or sharp-edged tools, e.g. screw-  
drivers.*

- In order to ensure optimal performance, it is essential that you acquaint yourself with this instruction manual, and the manual of the ARRIFLEX 535B.
- Use the IVS 535B only with ARRIFLEX 535B cameras, and only as described in this manual!
- Assembly and initial operation should only be carried out by persons who are familiar with the equipment!
- The video lens must be properly inserted into the CCD optic module, as incomplete insertion might result in damage to the beam splitter when attaching the unit to the camera body!
- Remove all cables before transport or servicing!
- Repairs should be carried out only by authorized service centers!
- Use only original ARRI replacement parts and accessories!
- Check all operations on the corresponding monitor!

## **Important Notes**

- In wet weather safety precautions for handling electrical equipment should be taken.
- Avoid operational errors!
- Do not touch optical surfaces!
- Clean optical surfaces only with a lens brush or a clean lens cloth! In cases of solid dirt moisten a lens cloth with pure alcohol.
- Do not use solvents to clean
- Do not use force!
- Do not remove any screws which are secured with paint!

## **Product Specifications**

In the case of inquiries or when ordering parts, please advise serial number and model.

- Always send the CCD optic module together with the inserter/antiflicker module in case of any service jobs.

## **Explanation of the Symbols in the Instruction Manual**

⇒ **photo** indicates objects which are shown in photographs or drawings.

All menus are shown in the respective typeface: **MENU**

Operating keys are represented in capitalized letters: **STO**

## 3 General Description of the IVS

The Integrated Video-Assist System (IVS) for the ARRIFLEX 535B ergonomically integrates with a minimum of external cabling a complete video assist system into the camera body. It offers unsurpassed image quality combined with a state-of-the-art inserter to add frame lines, time code, camera status and text into the video image.

### 3.1 Main Features

- **Integrated into the camera body:**  
Instead of a bulky add on, the video assist is an integral part of the camera.
- **High sensitivity:**  
A high speed lens with an aperture of 1: 1.4 and one of the most sensitive CCD-chips available on the market provide an excellent color video image in editing quality even when the light is set for high speed film stock to be pushed during processing.
- **High resolution:**  
The design of the new IVS optics was based on the 535B's viewfinder data and resulted in an image quality which can not be attained by add-on solutions.
- **Flicker-free:**  
An integrated digital frame store enables the video camera to be synchronized to the film camera's mirror shutter and provides a flicker-free video image from 5-60 fps. The recording of the video image is synchronized with the ideal position of the mirror shutter.
- **Integrated frame line inserter:**  
Frame lines can be electronically added to the video image. This ensures that the lines are visible even in low contrast conditions. The area outside the frame lines can be darkened electronically to emphasize the important image area.
- **Integrated IVS film counter:**  
In addition to the camera speed an independent IVS film counter can be inserted into the camera status line to support material logging.

- **Integrated time code inserter:**  
It is possible to insert time code into the video image. Thus, the video assist creates a reliable link to video editing. The information on "3:2" pull-down, which can be inserted as well, ensures the same reliability in an NTSC environment.
  - **Integrated text inserter:**  
Additional text like take numbers or production names can be added to the video image by sending characters via a serial interface.
  - **Additional Y/C Outputs:**  
In addition to the usual composite output, the IVS offers a Y/C output (S-VHS) for an even better video image without annoying color artifacts, with or without data inserted into the video image.
  - **On-Screen programming:**  
All functions which do not effect the image appearance directly, such as gain control, can be conveniently programmed with an onscreen menu on the video monitor.
  - **Image compare function:**  
It is possible to store a particular image and compare it against other images. This clearly shows the difference between the images, e.g. during stop effect shots.
  - **Automatic and manual gain control:**  
The gain is controlled automatically to its best value but can also be set manually.
  - **External synchronization input (Genlock):**  
The IVS has an external synchronization input to enable multiple camera use.
  - **Indoor/Outdoor and automatic white balance:**  
White balance can be set to indoor with 3200 K, outdoor with 5600 K and automatic adjustment.
  - **Mini monitor connector:**  
The IVS offers a connector for a 12 V LCD mini monitor.
- Note: If neither time code is used nor data is sent via the serial interface, it is possible to work without the data cable ZV4.
- Note: As the IVS is designed for an 80 : 20 beam splitter, there is no need for the 50 : 50 beam splitter, which is used for other color video assists.



## 3.2 System Components

### The IVS consists of:

- Optic Silent and/or ..... (K2.47298.0)
- Optic Academy ..... (K2.47301.0)
- Video Electronic complete ..... (K2.47306.0 for PAL  
or K2.47307.0 for NTSC)

### The complete video electronic consists of four parts:

- CCD Optic Module
- Inserter/Antiflicker module
- RS cable ..... (K4.47733.0)
- Data cable ZV4 ..... (K4.47730.0)

### Accessories for the IVS are:

- Software for text input ..... On request  
(for Macintosh / Windows)

### 3.2.1 Optic Silent

For a complete and working IVS, either the optic silent or the optic academy has to be installed inside the CCD optic module. These are easily interchangeable.

The optic silent forms an image on the CCD chip which is based on the 35 mm silent format with a picture width of 24 mm. To check for important objects outside the image recorded on film there is an additional area around the format markings.

The lenses are especially designed and built for use with the ARRIFLEX 535B to achieve the best image quality possible. The aperture of 1:1.4 is particularly important for use as video assist lenses: only a small portion of the light that passes through the camera lens goes to the video chip. The lenses are not designed as zoom lenses because it would be impossible to get the same image quality and speed.

All silent optics are marked with an S in the serial number, e.g. S0040.

There is no difference between lenses for PAL and NTSC.

### **3.2.2 Optic Academy**

For a complete and working IVS, either the optic silent or the optic academy has to be installed inside the CCD optic module. They are easily interchangeable.

The optic academy forms an image on the CCD chip based on the 35mm academy format with a picture width of 22mm. To check for important objects outside the image recorded on film there is an additional area around the format markings.

The lenses are especially designed and built for the use with the ARRIFLEX 535B to achieve the best image quality possible. The aperture of 1:1.4 is particularly important for use as video assist lenses: only a small portion of the light passes through the camera lens goes to the video chip. The lenses are not designed as zoom lenses because it would be impossible to get the same image quality and speed.

All academy optics are marked with an N in the serial number, e.g. N0040.

There is no difference between lenses for PAL and NTSC.

### **3.2.3 CCD Optic Module**

The CCD optic module, which is mounted on the ARRIFLEX 535B's viewfinder system, has to be equipped with a video lens. This module contains the CCD chip and all the necessary elements to center the video image on the TV-monitor screen and to adjust focus. It also houses a video pre-amplifier to increase the sensitivity of the IVS at low light conditions.

The CCD optic module is available in two versions for PAL or NTSC.

**Note:** It is necessary to keep the combination of CCD optic module and inserter/antiflicker module together as delivered. Mixing the modules might lead to reduced image quality.

### **3.2.4 Inserter/Antiflicker Module**

The compact inserter/antiflicker module, which is mounted on top of the ARRIFLEX 535B's electronic cover, holds the video camera electronic, an anti flicker processor and the entire inserter. All electronic control elements, as well as all in- and outputs are located here.

The inserter/antiflicker module is available in two versions for PAL or NTSC.

**Note:** It is necessary to keep the combination of CCD optic module and inserter/antiflicker module together as delivered. Mixing the modules might lead to reduced image quality.

### **3.2.5 RS cable**

The RS cable supplies the IVS with power and information regarding the camera speed and shutter mirror position. It plugs into the ARRIFLEX 535B RS connector and the inserter/antiflicker module. Please observe the color coding.

### **3.2.6 Data cable ZV4**

**Note:** Sending data to the film camera through the IVS is only possible when the IVS is switched on.

The data cable ZV4 is necessary to send additional information such as time code and RS 232 data to the IVS. This cable is necessary if time code is in use or if accessories such as the Laptop Camera Controller need access to the data interface of the IVS and the camera.

If neither time code is used nor data is sent via the serial interface, it is possible to work without the data cable ZV4.



## 4 Setup

### 4.1 Inserting the Optic

For a complete and working IVS, either the optic silent or the optic academy must be installed inside the CCD optic module.

A 1.5 mm allen key is used.



*Do not touch optical surfaces.  
All lenses must be clean.  
Do not use force.*

- Turn the protecting cap at the end of the CCD optic module ➤ **photo** counter clockwise and remove it to access the lens receptacle.
- Remove the cover on the front side of the CCD optic module ➤ **photo** by turning it counter-clockwise to access the alignment screw.
- Make sure that the focus screw (S3) ➤ **photo** and the alignment screws (S1, S2 and S4) ➤ **photo** are in the middle of their range.

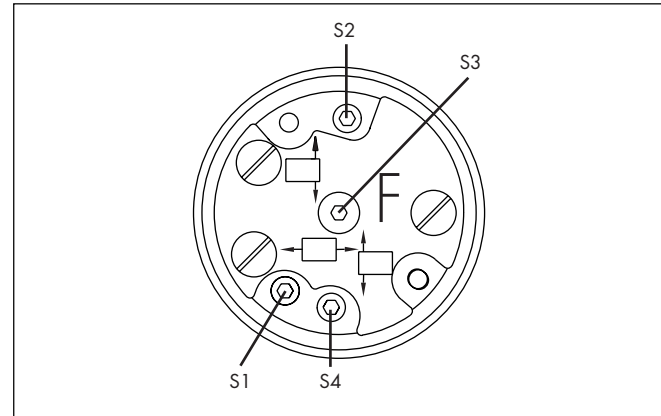
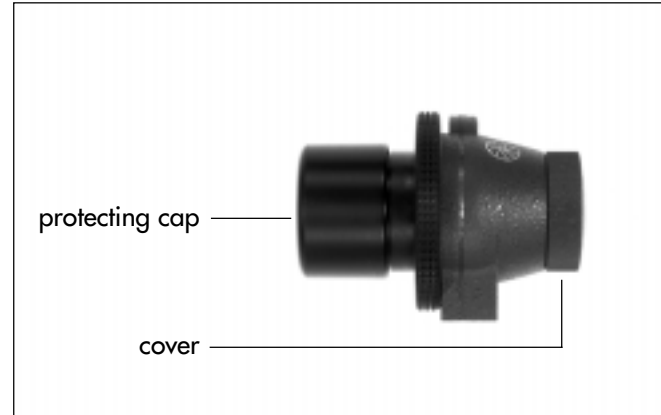

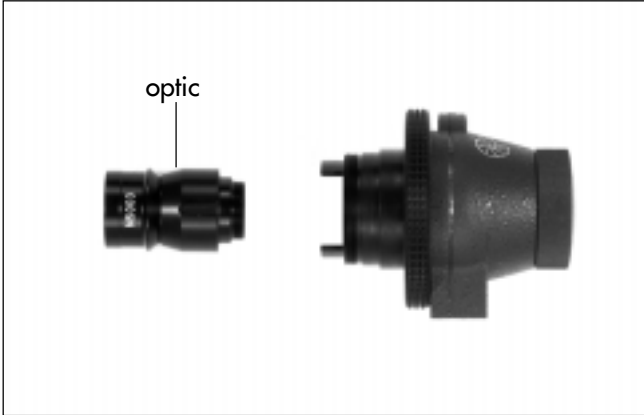

- Insert the video lens with the thread first into the CCD optic module as far as it will go ➔ **photo**.
- Turn the lens left or right to insert the iris key into its path and push the lens further in. Close the thread clockwise until the lens is secured.



*The video lens must be properly inserted into the lens mount until the end of the thread. Uncomplete insertion might result in damage to the beam splitter when attaching the unit to the camera body.*

- Re-attach the cover and protecting cap on the CCD optic module.
- To release the lens again, rotate carefully counter-clockwise until loose and pull forwards to remove.

## 4.2 Mounting the IVS on the camera

The following tools are needed to mount the IVS:

- 1.2 x 8 mm screwdriver or coin.

If the beam splitter is to be changed:

- Phillips screwdriver size 0
- Phillips screwdriver size 1
- 1.5 mm allen key
- Straight pair of tweezers.



*Disconnect camera from all power supplies.  
Do not use force  
Ensure clean contacts.*

The CCD optic module is mounted on the viewfinder of the ARRIFLEX 535B, the inserter/antiflicker module is placed on top of the electronic cover.

- Be sure to use a 80 : 20 beam splitter instead an 50 : 50 beam splitter. Change if necessary.

**Note:** Because of the high speed video optic (Academy or Silent), it is no longer necessary to use a 50: 50 beam splitter, as it was with other color video assists. The IVS is designed to work with an 80 : 20 beam splitter.



*Support the viewfinder system.  
Do not touch optical surfaces.*

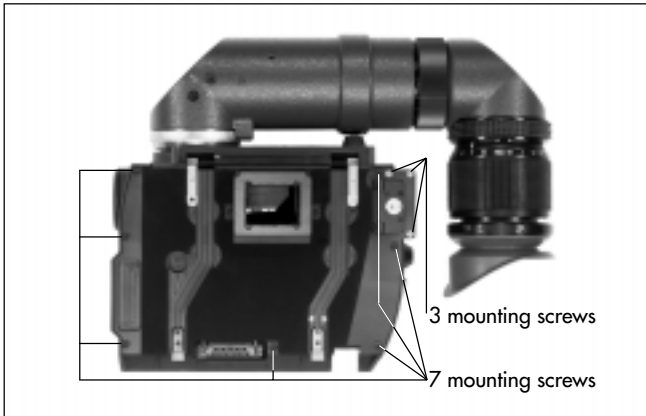
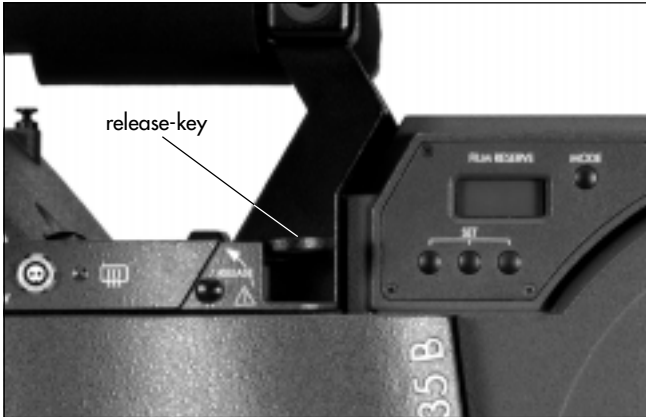

### 4.2.1 Changing the Beam Splitter

**Note:** This is not necessary if a 80 : 20 beam splitter is already installed.

Because of the high speed video optic (Academy or Silent), it is no longer necessary to use a 50:50 beam splitter, as it was with other color video assists. The IVS is designed to work with an 80:20 beam splitter.

- Press the release key ⇨ **photo** and take the viewfinder system off the camera.
- Open the 7 mounting screws ⇨ **photo**.
- Open the 3 mounting screws ⇨ **photo**.



*The viewfinder top is connected with two cables to the rest of the units.*

*Do not use force in separating the units.*

- Lift the top side of the viewfinder carefully off to get access to the beam splitter and mounting ring assembly.



- Open the connector locks with a pair of tweezers and disconnect the cables ⇨ **photo**.
- Take the viewfinder top off.
- Open the 2 screws of the beam splitter ⇨ **photo**.
- Take the beam splitter out of the camera. An adhesive tape on the top side of the beam splitter can be used to take it off. The side, which is marked with  $R = 80$  or  $R = 50$  ⇨ **photo** can be used for this.
- Put the new beam splitter into the camera. The alignment of the beam splitter is not critical. A visual check in the viewfinder is sufficient.
- Close the two screws on the beam splitter ⇨ **photo**.
- Connect the two cables between the viewfinder top and the base plate again ⇨ **photo**.
- Close the 3 mounting screws ⇨ **photo**.
- Close the 7 mounting screws ⇨ **photo**.
- Place the viewfinder system back to the camera.

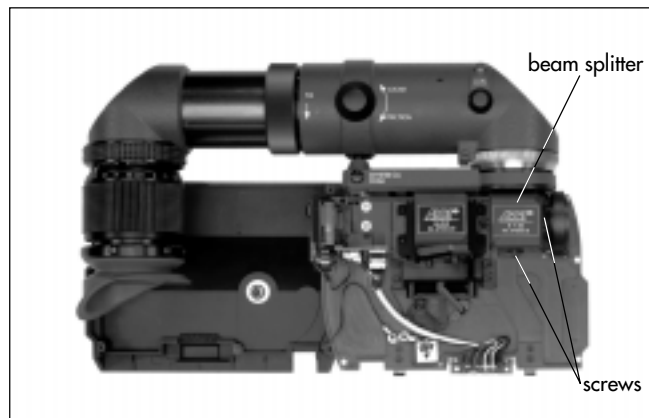
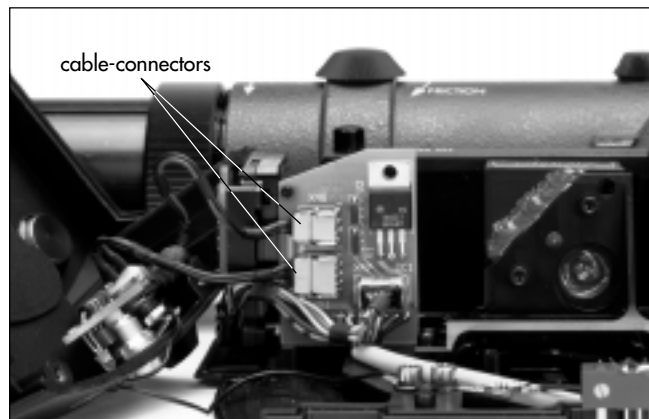

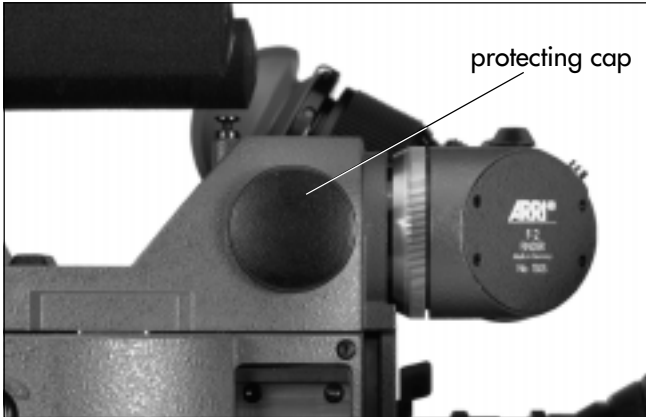

#### 4.2.2 Mounting the CCD Optic Module and the Inserter/Antiflicker Module

- Remove protecting cap of the video tap ⇨ **photo** by turning it counter-clockwise, and store it in case the camera is used without the IVS.
- Remove the protecting cap of the CCD optic module ⇨ **photo** by turning it counter-clockwise.



*The video lens must be properly inserted into the lens mount until the end of the thread. Uncomplete insertion might result in damage to the beam splitter when attaching the unit to the camera body.*

- Insert the CCD optic module into the video tap of the film camera with the lens first. Make sure the connector is pointing to the left side. Push the CCD optic module into the camera as far as it will go. Twist the module left or right until the key of the lens gear finds its path and insert the module further into the camera. Tighten the screw ring a little but do not close it entirely.
- Place the inserter/antiflicker module on the film camera and connect it to the CCD optic module. Insert the

attachment screw ⇨ **photo** into the camera handle without closing it and push the inserter/antiflicker module as far to the right as possible. Close the attachment screw on the camera handle.

- Secure the CCD optic module by closing the screw ring ⇨ **photo** clockwise.

### 4.2.3 Cabeling

- Connect the RS-cable ⇨ **photo** between the inserter/antiflicker module and the camera (RS-connectors). It is recommended to observe the color coding to ensure that the cable is as close to the camera as possible.
- Connect the data cable ZV4 ⇨ **photo** between the camera (CCU-connector) and the IVS (data connector).

Without a data cable ZV4 Time-Code and Pull-Down information as well as data transfer to the IVS via the serial interface are not available.

**Note:** If neither time code is used nor data is sent via the serial interface, it is possible to work without the data cable ZV4.

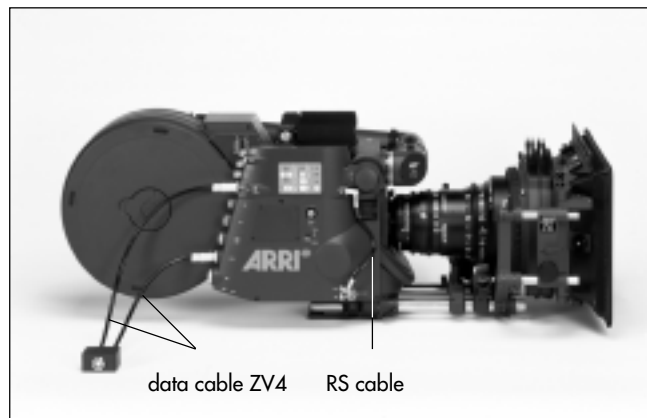
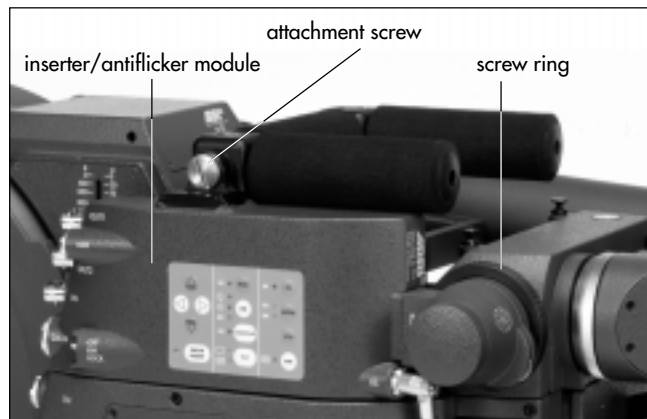

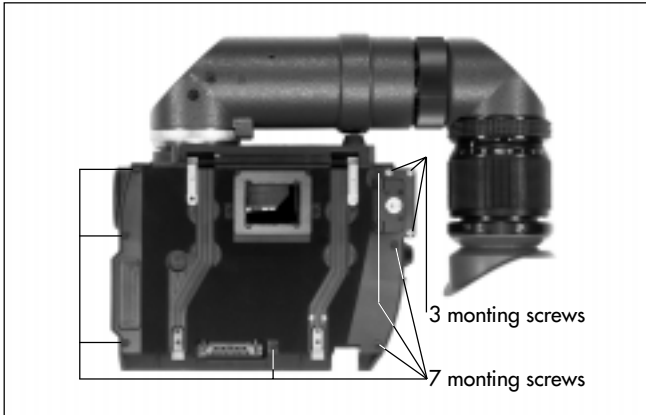
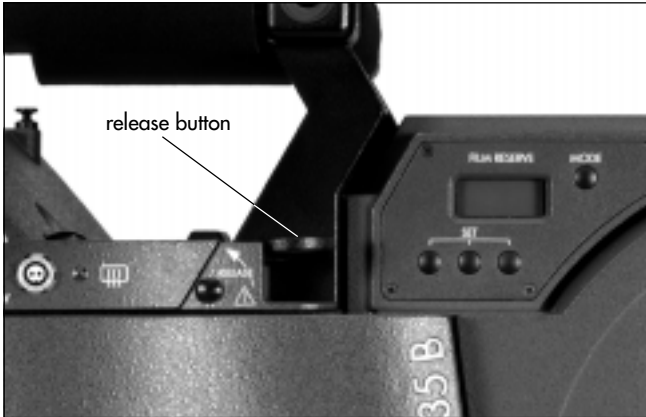

#### 4.2.4 Basic Alignment of the Video Output

If the video image can not be centered on the video monitor vertically, as described in chapter 5.3, it is possible to align the CCD optic module mount.

For this, the following tools are needed:

- Phillips screw driver size 0
- Phillips screw driver size 1
- 1.5 mm allen key



*Disconnect camera from all power supplies!  
Do not use force! Ensure clean contacts!  
Support the viewfinder system!  
Do not touch optic surfaces!*

- Take the viewfinder system off the camera by lifting the release button ⇨ **photo**.
- Open the 7 mounting screws ⇨ **photo**.
- Open the 3 mounting screws ⇨ **photo**.



*The viewfinder top is connected with two cables to the rest of the units.  
Do not use force in separating the units!*

- Lift the top side of the viewfinder carefully off to get access to the beam splitter and mounting ring assembly.
- Open the connector locks with a pair of tweezers and disconnect the cables ⇨ **photo**.
- Take the viewfinder top off.
- Place the viewfinder unit back to the camera.
- Open the 5 screws of the CCD optic module mount ⇨ **photo**, but do not take them out.
- Install the CCD optic module and the inserter/antiflicker module according to chapter 4.2.2.
- Remove the cover on the front side of the CCD optic module and make sure that the alignment screws (S1, S2, S3, S4) are in the middle of their range, as described in chapter 4.1.
- Swing the optic unit around screw 4 and 5 ⇨ **photo** so that the height of the video image is centered on the video screen.
- Close the screw 3 on the CCD optic module mount ⇨ **photo**.

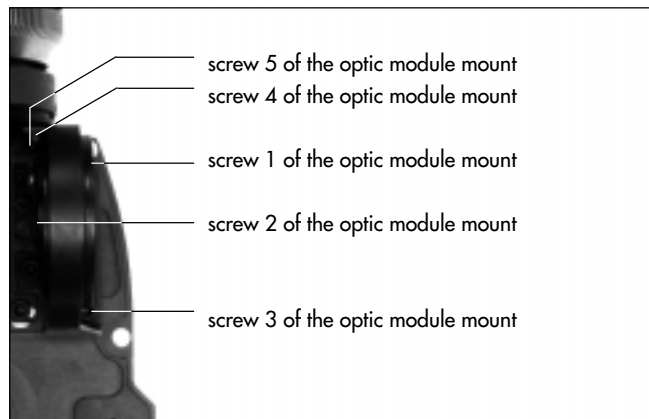
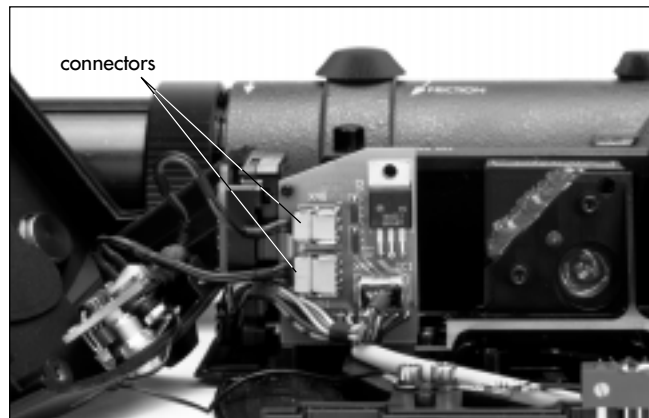

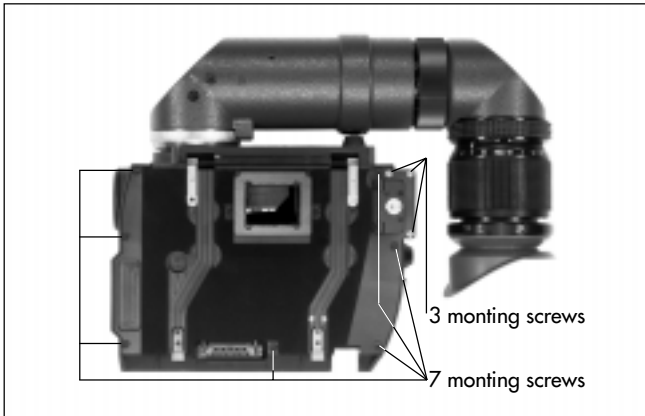
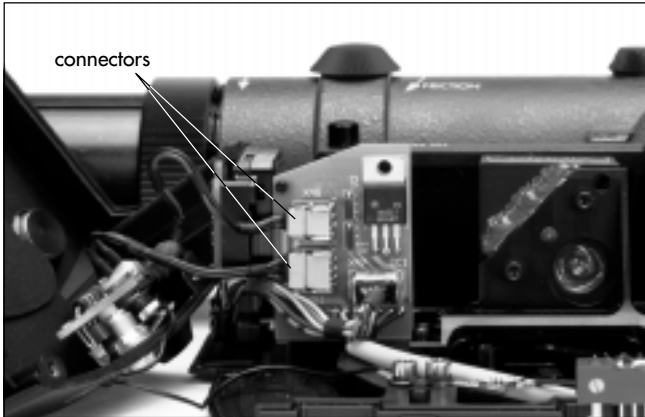

- Disconnect the RS- and the video cable.
- Take the Inserter/Antiflicker module off
- Take the CCD optic modul off.
- Close screw 1, 2, 4 and 5 on the CCD optic module mount.
- Take the viewfinder top off.
- Connect the two cables ⇨ **photo** between the viewfinder top and the base plate again.
- Close the 3 mounting screws ⇨ **photo**.
- Close the 7 mounting screws ⇨ **photo**.
- Place the viewfinder system back to the camera and mount the IVS as described in chapter 4.2.2.

## 4.2.5 Changing the Optic

The following tools are needed to change the optic:

- 1.2 x 8 mm screwdriver or a coin
- 1.5 mm allen key



*Disconnect camera from all power supplies.*

*Support the viewfinder system.*

*Do not touch optical surfaces.*

*All lenses must be clean.*

*Do not use force.*

*The video lens must be properly inserted into the lens mount until the end of the thread.*

*Incomplete insertion might result in damage to the beam splitter when attaching the unit to the camera body.*

- Disconnect the data cable ZV4 ⇨ **photo** if necessary.
- Disconnect the RS cable ⇨ **photo**.
- Take the inserter/antiflicker module off by opening the attachment screw ⇨ **photo** and shifting the inserter/antiflicker module off to the left.
- Take the CCD optic module off by opening the screw ring ⇨ **photo** on the CCD optic module and pulling the module out.
- Remove the cover on the front of the CCD optic module ⇨ **photo** by turning it counter-clockwise to access the alignment screw.

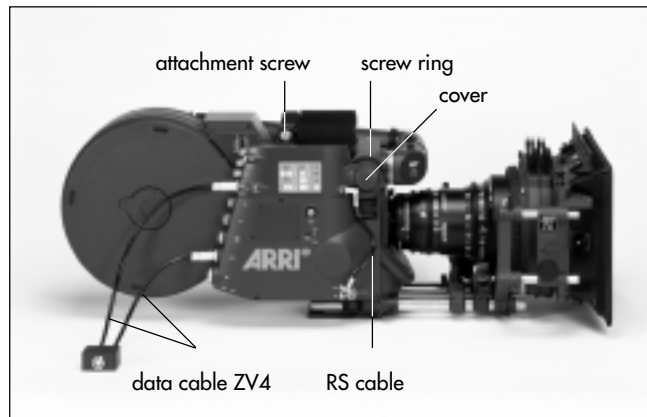

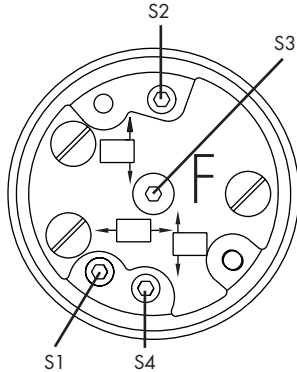

- Make sure that the focus screw (S3) ⇨ **photo** and the alignment screws (S1, S2 and S4) ⇨ **photo** are in the middle of their range.
- Place the cover back on the CCD optic module.
- Take the video lens out of the CCD optic module by turning the front ring of the lens counter-clockwise until loose and pull the lens forwards to remove.
- Insert the respective video lens with the thread first into the CCD optic module as far as it will go ⇨ **photo**. Turn the lens left or right to insert the iris key into its path and push the lens further in. Close the thread clockwise until the lens is secured.



*The video lens must be properly inserted into the lens mount until the end of the thread. Uncomplete insertion might result in damage to the beam splitter when attaching the unit to the camera body.*





- Insert the CCD optic module into the video tap of the film camera with the lens first. Make sure the connector is pointing to the left side. Push the CCD optic module into the camera as far as it will go. Twist the module a little left and right until the key of the lens gear finds its path and insert the module further into the camera. Tighten the screw ring a little but do not close it entirely.
- Place the Inserter/Antiflicker module on the film camera and connect it to the CCD optic module. Insert the attachment screw ⇨ **photo** into the camera handle without closing it and push the Inserter/Antiflicker module as far to the right as possible. Close the attachment screw on the camera handle.
- Secure the CCD optic module by closing the screw ring ⇨ **photo** clockwise.
- Connect the RS-cable ⇨ **photo** between the inserter/anti-

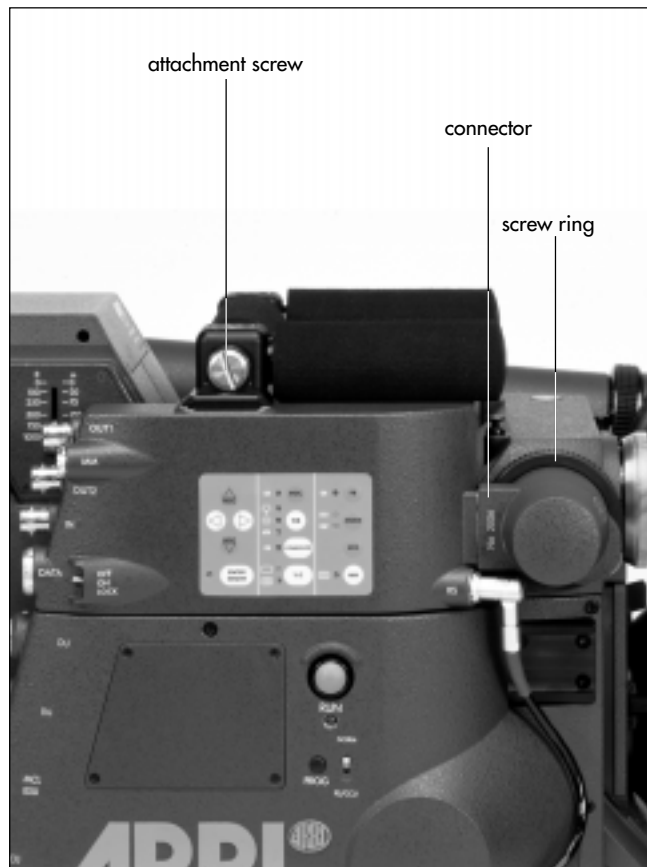

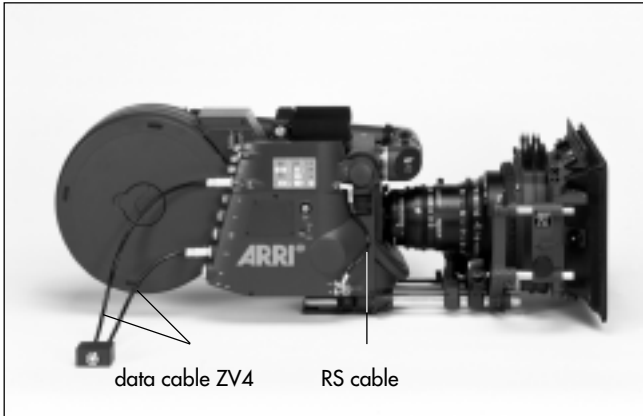

flicker module and the camera (RS-connector).

Note: It is recommended to observe the color coding to ensure that the cable is as close to the camera as possible.

- Connect the data cable ZV4 ⇨ **photo** between the camera (CCU-connector) and the IVS.

Without a data cable ZV4 Time-Code and Pull-Down information as well as data transfer to the IVS via the serial interface are not available.

Note: If neither time code is used nor data is sent via the serial interface, it is possible to work without the data cable ZV4.

## 4.2.6 Outputs and Inputs

### 4.2.6.1 Outputs

The IVS has two separate outputs for composite video, one output for Y/C that can be used alternatively, and one output for a mini monitor.

#### Composite Video Outputs

Composite video is only available if the COMPOSITE selector key on the keyboard is ON

- Composite video is switched on with the COMPOSITE key  
⇒ **photo**.

The LED indicates if composite video is on.

The difference between the outputs is that there is "normal video" on connector OUT 1 and "video with data" on OUT 2 (copposite mode).

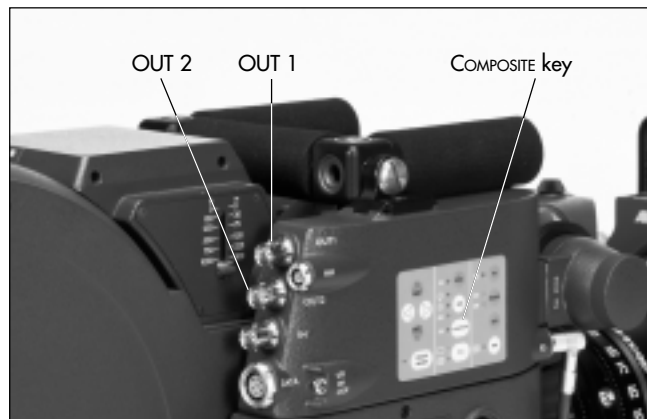

The "normal video" output (OUT 1) supplies almost no inserted electronic information. Only a flashing bar at the bottom left corner of the video image indicates a running film camera.

The "video with data" output (OUT 2) supplies additional inserted data such as format marks or time code.

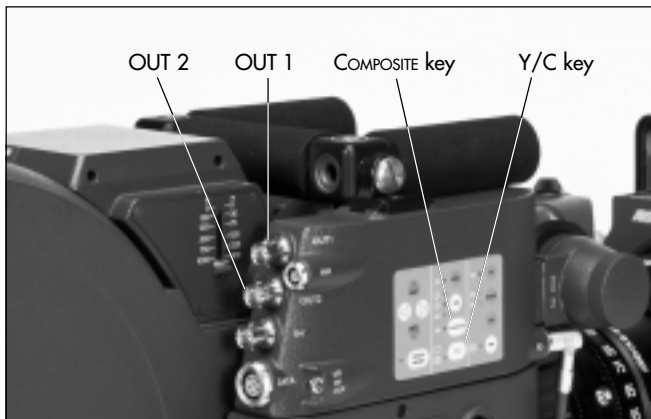

## Y/C Output

In comparison to the composite outputs, the Y/C output offers better S-VHS quality. The signal is available on the same pair of connectors from which the two composite video signals are outputted. To switch between composite and Y/C, use the **COMPOSITE** key ⇨ **photo** on the control panel.

Y/C video is only available while the **COMPOSITE** key on the keyboard is not ON

- Y/C video is switched on with the **COMPOSITE** key ⇨ **photo**.

The LED indicates if composite video is on: Y/C is selected when the LED is off.

There are also "normal video" and "video with data" signals available from the same pair of connectors. To switch between "normal video" and "video with data", use the Y/C key ⇨ **photo** on the control panel.

The LED next to the □ symbol indicates "normal video", the LED next to the ≡ symbol "video with data".

The "normal video" output supplies almost no inserted electronic information. Only a flashing bar at the button left corner of the video image indicates a running film camera.

The "video with data" output supplies additional inserted data such as format marks or time code.

Adapters from the two BNC connectors to a standard Y/C connector are available in many video shops.

**Note:** For a standard black and white output, use only the Y Signal with or without data.

## Mini Monitor Output

The IVS has a connector for a standard mini-monitor.

As there is only one mini monitor connector, it is possible to switch between "normal video" and "video with data" on this output.

- The output to the mini monitor will be altered at every press of the MM key ⇨ **photo**.

An illuminated LED indicates "video with data" on the mini monitor connector.

### 4.2.6.2 Inputs

It is possible to synchronize the IVS to an external video source. Furthermore, the IVS can be remote-controlled by a computer.

#### Genlock

The genlock input ⇨ **photo** allows the IVS to be synchronized to an external video source. This is necessary if several video cameras are used together.

Input is a standard composite video signal.

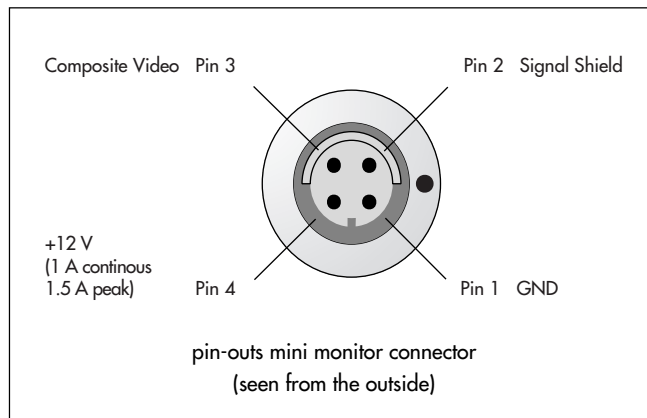
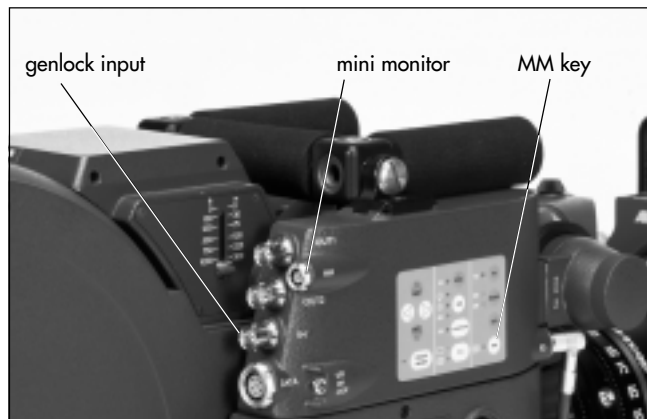

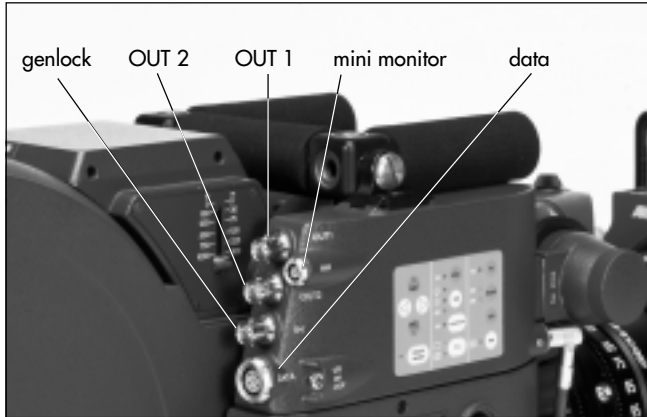

## **Remote Control**

All serial data, e.g. RCU information or remote control for the IVS must be sent into the serial data input of the data cable ZV4, regardless of whether the data is sent to the camera or the IVS.

All inserter functions of the IVS which can be called or set with the on screen menu can also be controlled via the ZV4 data cable's CCU interface.

As corresponding software the ARRI Laptop Camera Controller is available on request (refer to separate manual).

# 5 Standard Video Controls

The IVS can be used like a standard video assist if no inserter functions are used.

Note: For exchanging the optic between academy and silent format, refer to chapter "Changing the Optic", 4.2.5.

Note: All currently used settings are stored even if the IVS or the camera is switched off. After restarting the IVS the settings are unchanged.

## 5.1 Off/ On and Locking the Keyboard

The IVS can be switched on and off independently from the film camera. As long as the film camera is switched off, the IVS is also off.

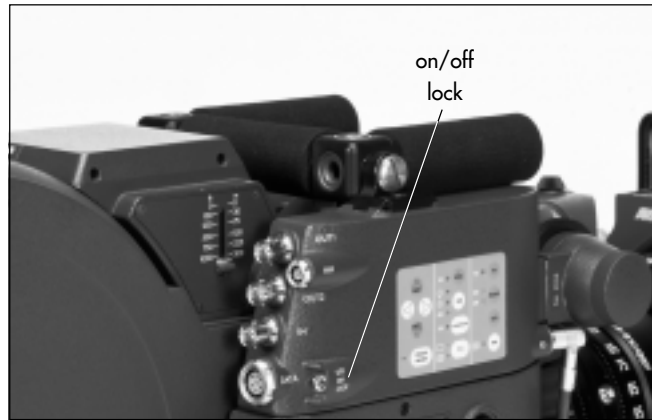

- The OFF position switches the IVS off without affecting the film camera. ON activates the IVS, and LOCK disables the keyboard to prevent unintentional handling  photo.

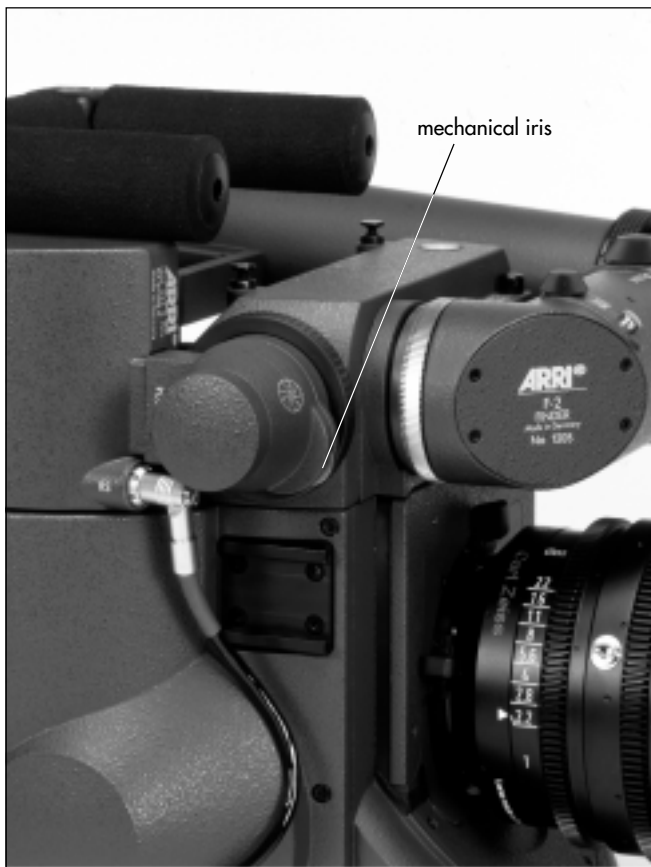

## 5.2 Mechanical Iris

Only a relatively small portion of the light which passes through the film camera's lens goes to the CCD chip of the video assist, as the light is shared between the viewfinder, the CCD chip and the film. Therefore the IVS lenses are designed for normal usage with a totally open iris to have maximum light on the CCD chip. Variations in lighting are compensated by the IVS gain control (automatically or manually).

Under certain conditions, such as when lighting is set for low sensitivity film (under 100 ASA) or for motion effects, it is possible that the IVS gain range is exceeded. In this case the mechanical iris of the IVS lens can be closed.



*Check all settings on the connected monitor. If the mechanical iris is closed more than necessary, the IVS will compensate by increasing the gain and improve the image brightness electronically. This creates additional electronic noise. To avoid this, always open the mechanical iris as far as possible.*



## 5.3 Aligning the Image and Focusing

The position of the image on the CCD chip can vary slightly from film camera to film camera. The video image on the monitor may appear not centered. In addition, it is necessary to focus the lens on every new film camera.

All settings can be made by using a 1.5 mm allen key.



*Do not use force!*

Both adjustments can be made on the CCD optic module.

**Note:** Make sure that the iris is fully open during focusing in order to optimize focus.

- Remove the cover  **photo** located at the end of the module by twisting it counter-clockwise to access alignment screws.

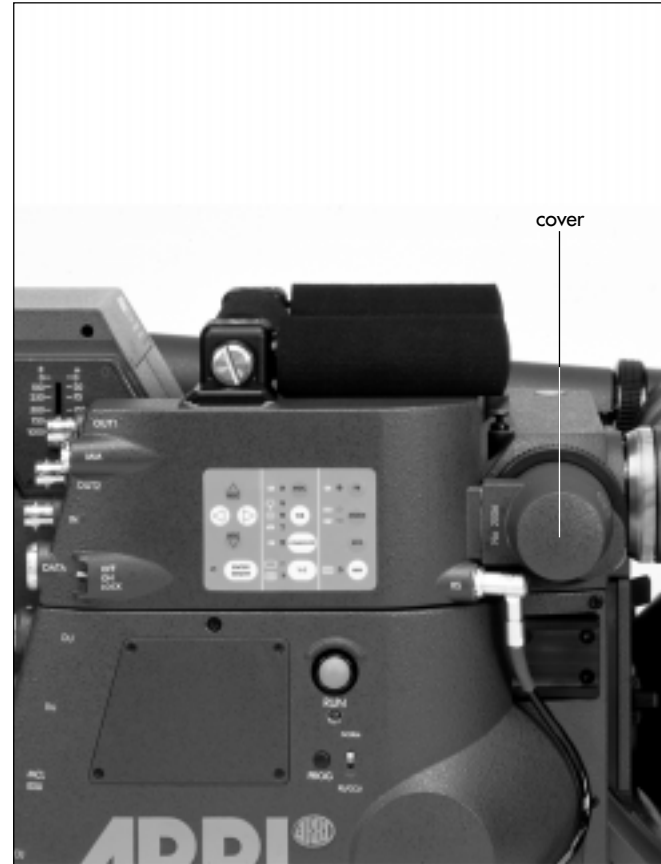

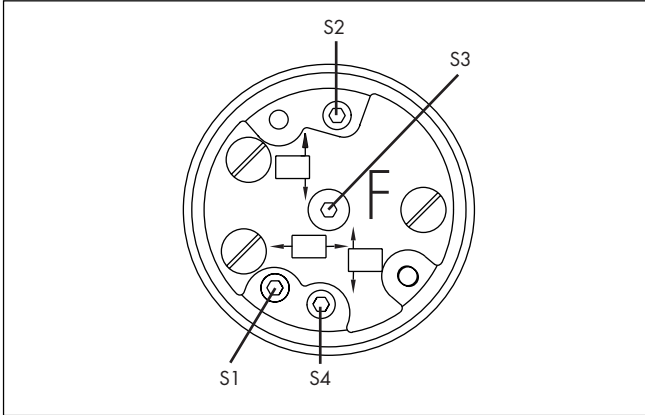

- Screw S1 moves the video image on the monitor horizontally.  
Screw S2 rotates the image around a point which is located in the middle of the left side,  
and screw S4 rotates the image around a point which is located in the middle of the right side.  
Screw S3 will focus the lens.
- Re-attach the cover after adjusting.

## 5.4 White Balance (WB)

The IVS offers a choice for white balance between an automatic control (ATW) or a fixed setting for indoor (☀) or outdoor (☀).

If automatic white balance (ATW) is selected ⇨ **photo**, the IVS will automatically set white balance. For this no white card reading is necessary.

If indoor (☀) is selected ⇨ **photo** white balance is optimized for tungsten lighting with 3200 K.

The outdoor setting (☀) ⇨ **photo** optimizes the white balance for daylight with 5600 K.

- By pressing the key WB ⇨ **photo**, the setting will be changed from indoor, outdoor to automatic white balance and back to indoor. Illuminated LEDs show the selected mode.



*Check all settings on the connected monitor.*

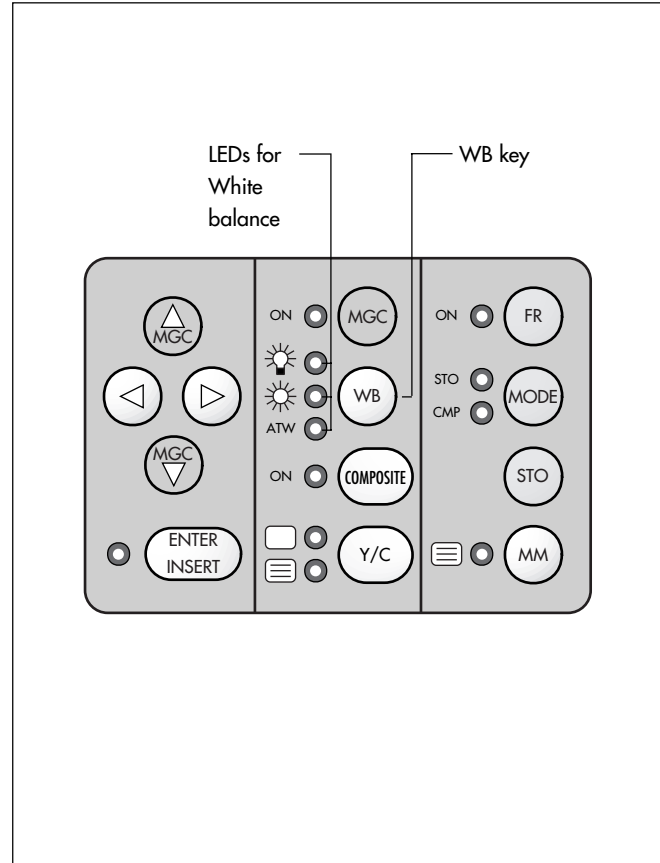

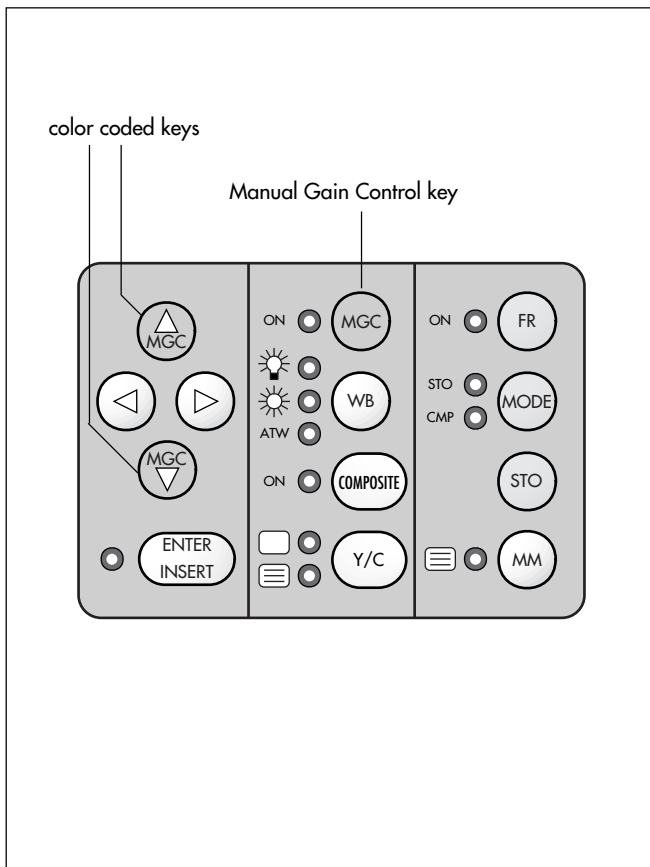

## 5.5 Gain Control

The IVS can control the brightness of the video image electronically. This gain control can be automatic or manual.

If the automatic control is selected, the IVS outputs the best possible image brightness at all times. Light changes in front of the film camera are compensated by the IVS; the brightness impression remains almost unchanged.

- By pressing "Manual Gain Control" (MGC) the setting alters between manual and automatic control. An illuminated LED shows the setting manual gain control.
- The brightness of the video image can be manually altered if manual gain control is selected. By using the color coded keys Manual Gain Control (MGC) ▲ or Manual Gain Control (MGC) ▼, brightness can be increased or decreased. An automatic compensation of different light levels in front of the camera is suppressed.



*Check all settings on the connected monitor.*

## 5.6 Frame Store and Compare

The IVS can store one video image and compare it against the currently incoming images.

**Note:** There is no image stored when the IVS is switched on. A random image pattern is displayed when the frame store is activated for the first time. After pressing the key **STO** a real image is stored and displayed.

- To store video images, activate the frame store mode by pressing the key **MODE**. The **STO** LED is illuminated indicating the store mode. By pressing the key **STO** it is possible to grab one video image.



*The image remains stored only until another frame is stored, or until the IVS or the film camera is switched off or disconnected from the power supply.*

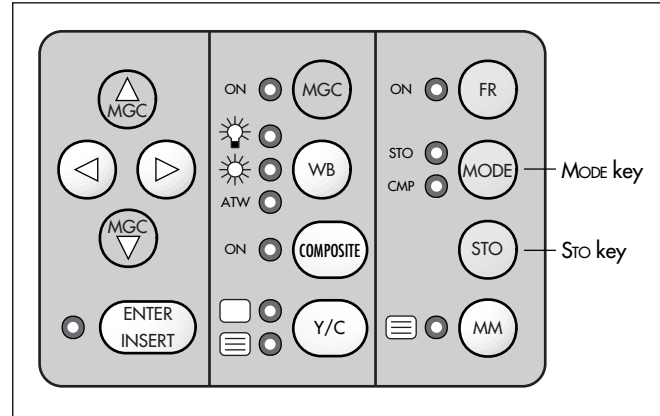

- To activate the compare mode, press the key **MODE** after one image has been stored. The illuminated **CMP** LED indicates this mode. The stored image is superimposed on the presently incoming video image. Differences between the two images can be seen easily.
- By pressing the key **MODE** the IVS goes from normal mode to store mode to compare mode and back to normal mode. Every time the key **STO** is pressed when the IVS is in store mode, a new video frame is grabbed.

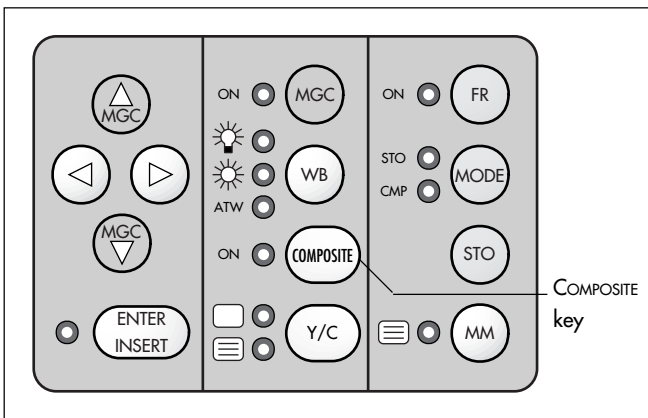

## 5.7 Switching between Composite Video and Y/C

The IVS outputs video either as composite video or Y/C video. As both signals use the same connector, it is possible to switch between the two by pressing the COMPOSITE key (see also chapter 4.2.6.1).

The LED indicates composite video on.

- Every time the COMPOSITE key is pressed, the signal on the output connectors alters.

The signal on OUT 1 ⇨ **photo** changes from composite video "normal video" to Y signal and back.

The signal on OUT 2 ⇨ **photo** changes from composite video "video with data" to C signal and back.

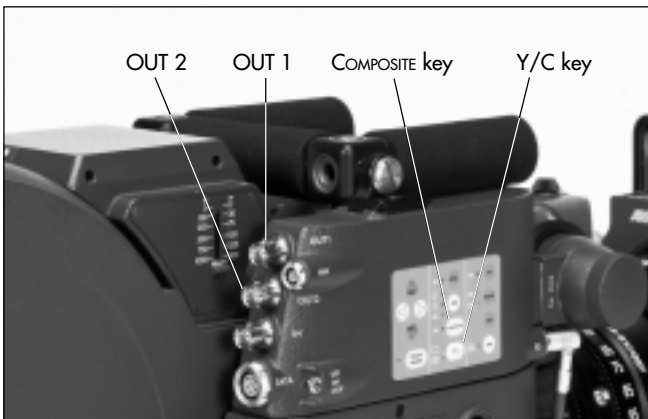

## 5.8 Flicker free on/off

The IVS suppresses the flickering of the video image, which normally occurs when the film camera and the video camera are running at different frame rates or if they are not in phase.



*The time code information is not valid if flicker reduction is switched off.*

- The flicker reduction key FR ⇨ **photo** switches the anti flicker facility on and off should this become necessary, e.g. for motion control shots.

The LED indicates flicker free on.

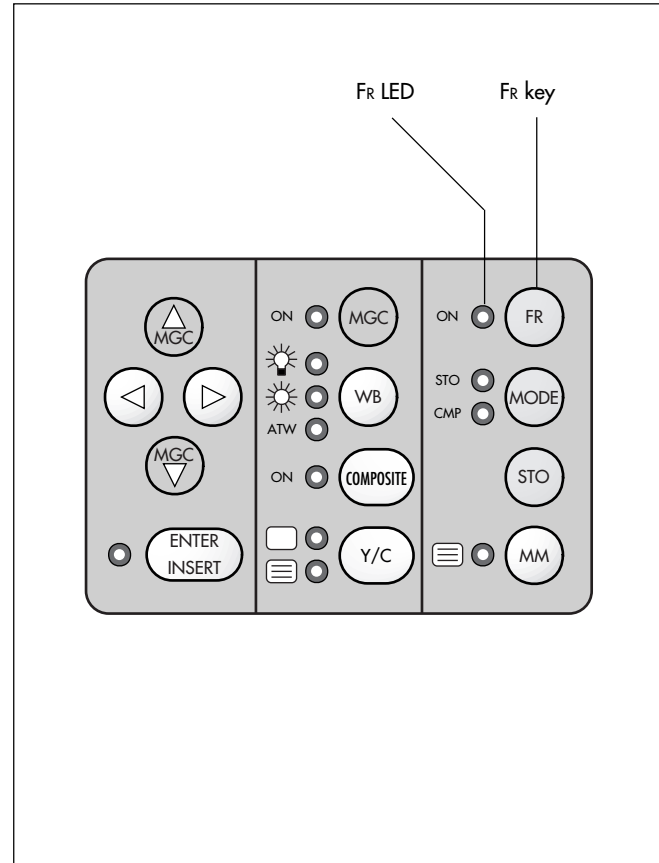





## 6 Inserter Facilities

In addition to the usual video assist functions, the IVS offers a variety of inserter facilities.

There are three different groups of information:

- **Format markings**

Format markings, which are inserted electronically, are often more visible than format markings on the ground glass or on the ARRIGLOW.

- **Man readable information**

Time code  
User bits  
Camera status  
IVS filmcounter  
Additional text  
Pull down information

- **Machine readable information**

VITC  
White line flag



*All inserted data is only available at the outputs "video with data". All engravings from the ground glass (i. e. TV-Safe etc.) are visible at all times at all outputs.*

Note:

All currently used settings are stored even if the IVS or the camera is switched off or disconnected from the power supply. After restarting the IVS the settings are unchanged.

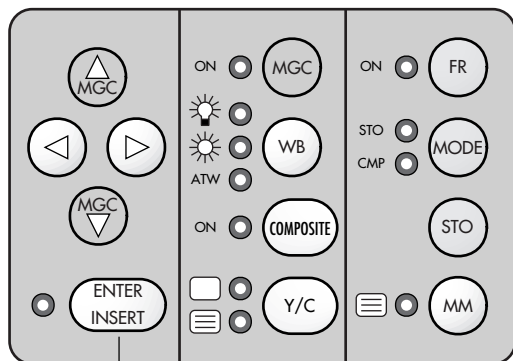

ENTER INSERT key

## 6.1 Setting the On Screen Displays

**Note:** The on screen displays are only available at OUT 2 if composite is selected. In case of Y/C or mini monitor output, the on screen displays are available when "video with data" is selected.

An illuminated LED indicates that on screen programming is activated.



*During programming the inserted data is not fully updated (i. e. Pull down information, TC-Frame Count).*

*To get information updated, leave the on screen display menu by pressing the key ENTER INSERT for more than three seconds.*

- Once the onscreen display is activated by pressing the key ENTER INSERT for more than three seconds, the following procedure is used to select and set all functions within the main menu and the sub menus:

- Pressing the key  $\uparrow$  or  $\downarrow$  will move the cursor  $\rightarrow$  up or down. Pressing the key  $\rightarrow$  or  $\leftarrow$  activates sub menus.
- Within sub menus the cursor  $\rightarrow$  can be moved up and down again by pressing the key  $\uparrow$  or  $\downarrow$ . The keys  $\rightarrow$  or  $\leftarrow$  will now change settings (e. g. switch the insertion of a time code window on and off), or activates functions (position mode of a window, **EXIT** or the **ALL STANDARD** call).
- If the window's position mode is activated, the keys  $\uparrow$ ,  $\downarrow$ ,  $\rightarrow$  or  $\leftarrow$  will move the window across the video image. To leave the position mode press the key **ENTER INSERT** briefly.
- To go from a sub menu back to the main menu, position the cursor  $\rightarrow$  by using the keys  $\uparrow$  and  $\downarrow$  on the line **EXIT** and press the key  $\rightarrow$  or  $\leftarrow$ .



*All settings are immediately activated by changing them.*

Note:

Pressing the key **ENTER INSERT** for more than three seconds will cause the system to exit the onscreen programming mode completely, regardless of which menu is activated, with the exception of the positioning mode.

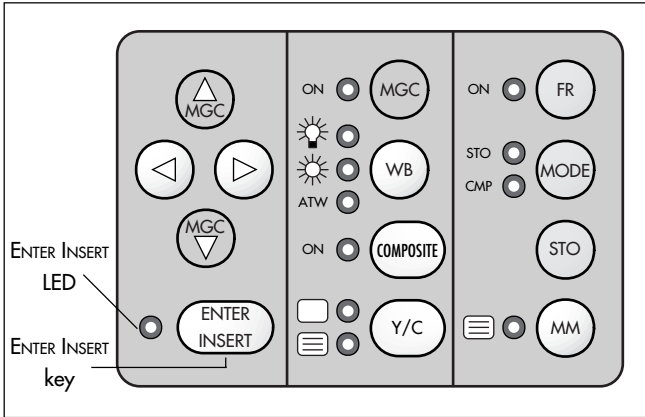

## 6.2 Main Menu

The inserter's main menu is displayed on the monitor screen when onscreen programming is activated by pressing the key ENTER INSERT for more than three seconds.

An illuminated LED indicates that onscreen programming is activated.

**Note:** Pressing the key ENTER INSERT for more than three seconds will cause the system to exit the onscreen programming mode completely, regardless of which menu is activated, with the exception of the positioning mode.

- The keys ⬆ or ⬇ will move the cursor ➤ up or down. Pressing the key ⬇ or ⬆ will lead into a sub menu.



## 6.3 Format Markings Menu

The IVS can insert two different format markings electronically in the video image, either individually or simultaneously. The position of these format markings can be set anywhere on the screen to line up exactly with the ground glass markings. Brightness is adjustable in four steps and the area outside one format marking can be electronically darkened.



*All settings are immediately activated by changing them.  
Check all settings on the connected monitor.*

- Enter the **FORMAT MARKING** submenu from the Main menu.



```

SUB MENU
> FORMAT      1
  POSITION      1
  EDGE        1
  WHITE
  LEVEL       3
  OUTSIDE     FULL
  EXIT
  
```

## 6.3.1 Activate Format Markings

It is possible to have no format marking (**OFF**), format marking number one (**1**), format marking number two (**2**) or both format markings at the same time (**1 & 2**) on display.

If the electronic format markings are not parallel to the ground glass format markings, readjust the CCD chip with the alignment screws on the CCD Optic Module (chapter 5.3).

- Move the cursor **>** with the keys **⬆** and **⬇** to the line **FORMAT**. Pressing the key **⬅** will switch from **OFF** to **1** to **2** to **1 & 2** and back to **OFF**, the key **➡** will switch in the opposite direction.

**Note:** Pressing the key **ENTER INSERT** for more than three seconds will cause the system to exit the onscreen programming mode completely, regardless of which menu is activated, with the exception of the positioning mode.

### 6.3.2 Position - Positioning of the Format Markings

The format markings can be adapted to every different format. The format markings on the ground glass serve as a reference.

To align the electronic format markings with the ground glass markings proceed as follows:

- Point the film camera towards a bright object so that the format markings on the ground glass are clearly visible.
- Move the cursor  $\blacktriangleright$  with the keys  $\text{⬆}$  and  $\text{⬇}$  to the line **POSITION**. Call the positioning mode with the keys  $\text{⬅}$  or  $\text{⬄}$ . The sub menu is displayed on the screen  $\Rightarrow$  **photo**.

The symbol  $\text{1}\Gamma$  indicates that it is now possible to move the left and the upper line of format 1.

The keys  $\text{⬅}$  or  $\text{⬄}$  move the vertical line right or left, the keys  $\text{⬆}$  or  $\text{⬇}$  move the horizontal line up and down.

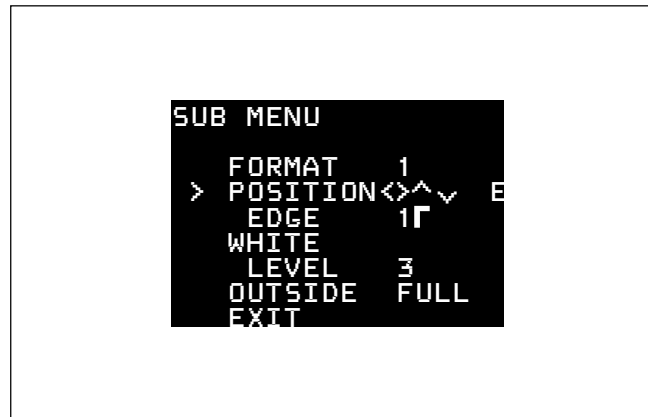

- When the correct position has been set, confirm by pressing the key ENTER INSERT briefly.

The symbol will now change from  $\text{1}\Gamma$  to  $\text{1}\perp$ . It is now possible to set the lower and right line with the keys  $\text{⬆}$ ,  $\text{⬇}$ ,  $\text{⬅}$  or  $\text{⬄}$ .

- When the correct position has been set, confirm by pressing the key ENTER INSERT briefly.

If both format markings are activated, the symbol  $\text{2}\Gamma$  is now displayed. In this case the left and upper line of format 2 can be set. Proceed as described above.

```

SUB MENU
  FORMAT      1
  POSITION
  EDGE        1
  > WHITE
  LEVEL       3
  OUTSIDE     FULL
  EXIT
  
```

```

SUB MENU
  FORMAT      1
  POSITION
  EDGE        1
  WHITE
  LEVEL       3
  > OUTSIDE     FULL
  EXIT
  
```

### 6.3.3 White Level - Setting the brightness of the Format Markings

The brightness of the format markings can be set to black (0), dark gray (1), light gray (2) or white (3).

- Move the cursor > with the keys Ⓐ and Ⓑ to the line **WHITE**. Pressing the key Ⓒ will switch the settings from 0 to 1 to 2 to 3 and back to 0, pressing the key Ⓓ will switch the settings in the opposite direction.

### 6.3.4 Outside - Darkening the Area outside the Format Markings

Note: This function is only available if one format marking is activated. No darkening function is available if there is no format marking or if two format markings are switched on.

The brightness of the area outside of one format marking can be reduced electronically to emphasize the important image area. The setting **FULL** shows the outside area with normal brightness, the setting **DARK** will reduce the brightness of that area.



- Move the cursor > with the keys ⬆ and ⬇ to the line **OUTSIDE**. Pressing the key ⬇ or ⬆ will switch between **FULL** and **DARK**.

### **6.3.5 Exit**

Return to the main menu using Exit.

- Move the cursor > with the keys ⬆ and ⬇ to the line **EXIT** and press the key ⬇ or ⬆.

Note: Pressing the key ENTER INSERT for more than three seconds will cause the system to exit the onscreen programming mode completely, regardless of which menu is activated, with the exception of the positioning mode.

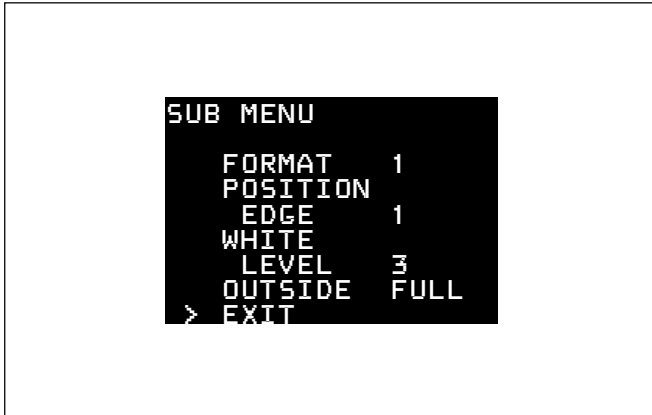



## 6.4 Status Menu

The IVS can insert the camera status into the video image. The following information is available:

- **STANDBY** or **RUN**
- Forward (**FWD**) or Reverse (**REV**)
- Film camera speed in full frames per second
- IVS film counter

The information on forward or reverse run is also displayed if the film camera is in standby. In this case the information refers to the selected camera running direction.

The information on camera speed always displays the current film camera speed. The corresponding digits are blanked out if the camera is in standby.



*The data is displayed only in full frames. A camera speed of 23.976 fps would be displayed as 24 fps.*

The IVS film counter is an independent counter which is not linked to the film camera's film counter. It can be set to count up or down. It can be set to any number or it can be reset.

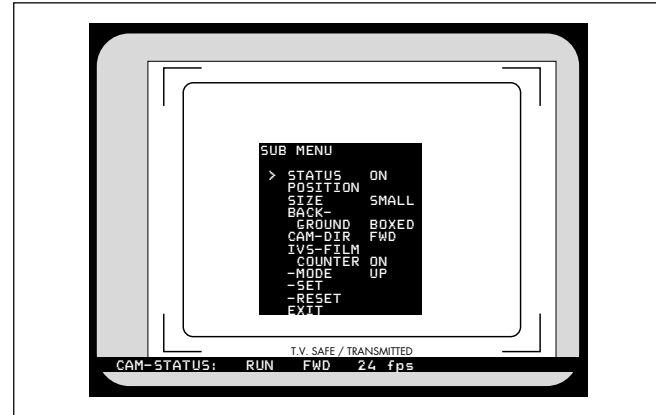

Like all man-readable information, the data is inserted as a window on the monitor image. The window can be switched on and off independently. Background, position and character format can be altered without affecting the settings of other windows.

This additional line shows the camera status:



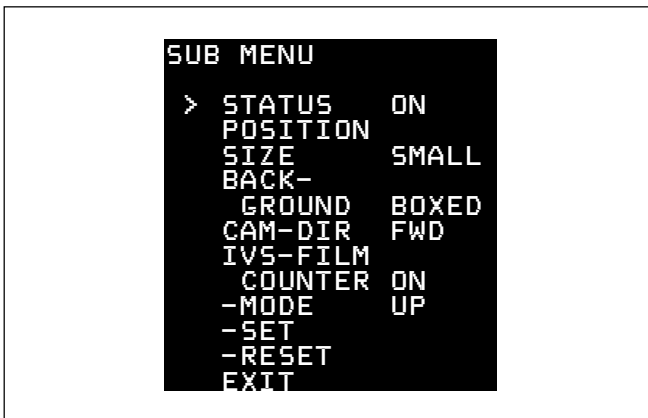
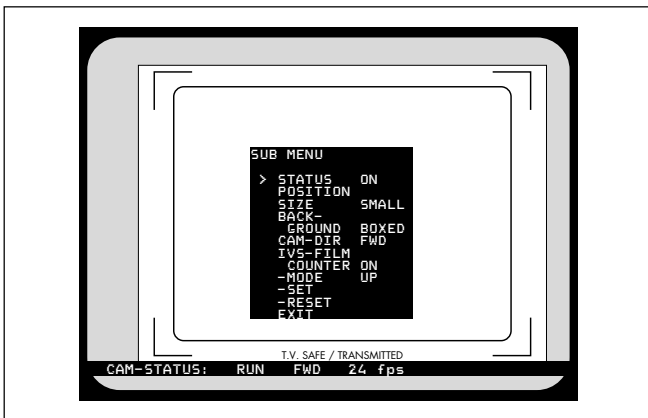

The adjustment of the white level of the inserted data, an inverse display and a fine adjustment of the vertical position are described in chapter 6.9

- Enter the **STATUS MENU** from the Main Menu.



*All settings are immediately activated by changing them.  
Check all settings on the connected monitor.*

## 6.4.1 Status

This sub menu line switches the insertion of camera status data on (**ON**) and off (**OFF**) independently of other inserted data.

- Move the cursor **>** with the keys **⬆** and **⬇** to the line **STATUS**. The keys **⬅** and **➡** switch the insertion on and off.

## 6.4.2 Position

The window can be positioned anywhere on the monitor screen.

- Move the cursor  $\blacktriangleright$  with the keys  $\Delta$  and  $\nabla$  to the line **POSITION**. Call the positioning mode with the keys  $\odot$  or  $\ominus$ . The following menu is displayed on the screen:

```
> POSITION ^ v E
```

- The keys  $\Delta$  and  $\nabla$  move the window up and down.
- When the desired position has been set, confirm by pressing the key ENTER INSERT.

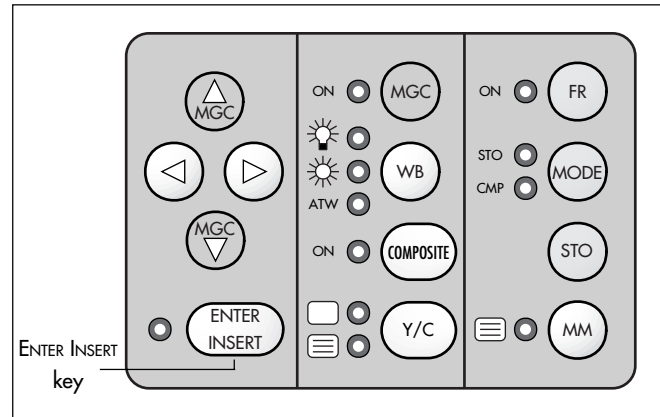
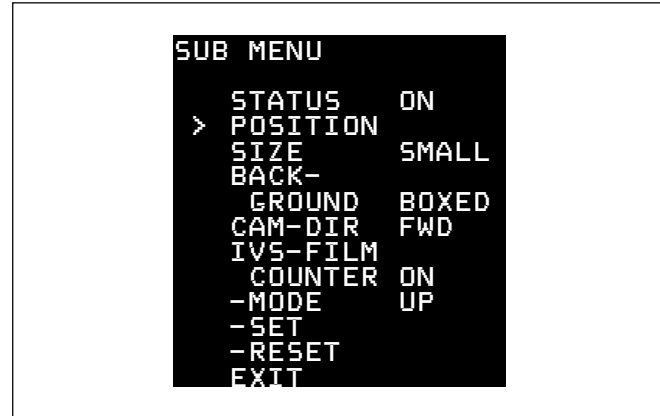

```

SUB MENU
  STATUS      ON
  POSITION
  > SIZE      SMALL
  BACK-
  GROUND      BOXED
  CAM-DIR     FWD
  IVS-FILM
  COUNTER     ON
  -MODE       UP
  -SET
  -RESET
  EXIT
  
```

```

SUB MENU
  STATUS      ON
  POSITION
  > SIZE      SMALL
  BACK-
  GROUND      BOXED
  CAM-DIR     FWD
  IVS-FILM
  COUNTER     ON
  -MODE       UP
  -SET
  -RESET
  EXIT
  
```

### 6.4.3 Size

The format of the inserted characters can be changed independently from other windows from **SMALL** to **WIDE** to **HIGH** to **BIG**.

- Move the cursor **>** with the keys **⬆** and **⬇** to the line **SIZE**. Pressing the key **⬅** will change the setting from **SMALL** to **WIDE** to **HIGH** to **BIG** and back to **SMALL**. The key **➡** will switch in the opposite direction.

### 6.4.4 Background

The background of the window can be set electronically to black (**BOXED**) to improve readability. If this is not activated, the area around the text is the normal video image (**VIDEO**).

- Move the cursor **>** with the keys **⬆** and **⬇** to the line **BACK-**. The keys **⬅** and **➡** will switch between **BOXED** and **VIDEO**.

### 6.4.5 Camera Direction

The camera run direction forward **FWD** or reverse **REV** must be set in the IVS in order to get valid IVS film counter information in the display windows.

- Move the cursor  $\>$  with the keys  $\odot$  and  $\oplus$  to the line **CAM-DIR**. The keys  $\ominus$  and  $\odot$  will switch between forward and reverse.

```

SUB MENU

STATUS      ON
POSITION
SIZE        SMALL
BACK-
  GROUND    BOXED
> CAM-DIR   FWD
IVS-FILM
COUNTER     ON
-MODE       UP
-SET
-RESET
EXIT
  
```

### 6.4.6 IVS Film Counter On/Off

The IVS film counter is an independent footage counter. It is not slaved to the footage counter of the film camera and can be used in parallel. It can be switched to be displayed in the camera status line.

The IVS film counter can be set to count upwards or downwards (i. e. to show remaining film stock), it can be set to any film length or cleared.

```

SUB MENU

STATUS      ON
POSITION
SIZE        SMALL
BACK-
  GROUND    BOXED
> CAM-DIR   FWD
IVS-FILM
COUNTER     ON
-MODE       UP
-SET
-RESET
EXIT
  
```

```
SUB MENU
STATUS      ON
POSITION
SIZE        SMALL
BACK-
GROUND      BOXED
CAM-DIR     FWD
> IVS-FILM
  COUNTER   ON
  -MODE     UP
  -SET
  -RESET
  EXIT
```

The sub menu line **IVS FILM COUNTER** switches the IVS film counter on and off.

```
CAM-STATUS:  RUN   FWD   24 fps  107 m
```

```
CAM-STATUS:  RUN   FWD   24 fps
```

- Move the cursor **>** with the keys **⬆** and **⬇** to the line **IVS-FILM**. The keys **⬅** and **➡** will switch between IVS film counter on and off.

If the IVS film counter is on, the status line displays film counter information otherwise the information is blanked out.

Note: The accuracy of the IVS filmcounter depends on the chosen unit for measurement – m or ft – and is displayed in full units.



## IVS Film Counter Mode

The IVS film counter can be set to count up or down. In the count up mode, it is possible to see the footage which has run through the camera.

In the count down mode, it is possible to see how much film is left, if the length of the film that was loaded was entered before. This procedure is described in the next paragraph.

This sub menu line switches the IVS film counter mode from count up to count down.

- Move the cursor  $\blacktriangleright$  with the keys  $\odot$  and  $\oplus$  to the line **-MODE**. The keys  $\ominus$  and  $\omin�$  will switch between IVS film counter mode **UP** and **DOWN**.

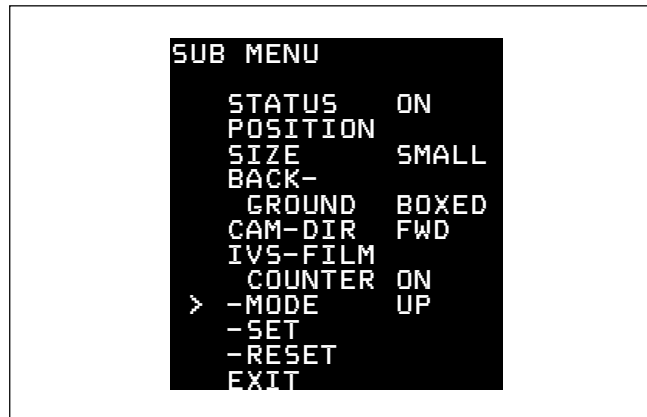

```

SUB MENU
STATUS      ON
POSITION
SIZE        SMALL
BACK-
GROUND      BOXED
CAM-DIR     FWD
IVS-FILM
COUNTER     ON
-MODE       DOWN
> -SET      0107m E
-RESET     ^
EXIT       ^
    
```

```

> -SET      0107m E
-RESET     ^
EXIT       ^
    
```

```

> -SET      0107m E
-RESET     ^
EXIT       ^
    
```

```

> -SET      0107m E
-RESET     ^
EXIT       ^
    
```

## IVS Film Counter Set

The IVS film counter can be preset to a given value. This enables the user to set the length of the film material and have an indication of the remaining film length in the magazine.

Note: For counting the remaining film the IVS film counter mode must be set to count down.

- Move the cursor  $\>$  with the keys  $\odot$  and  $\oplus$  to the line **-SET**. Pressing the keys  $\ominus$  or  $\omin�$  will lead into the set menu. Within this set menu, it is possible to change the active digit which is the digit, marked with the  $\wedge$  symbol.
- The  $\ominus$  key will move the  $\wedge$  symbol from the first digit one digit right.
- By pressing the same key, the  $\wedge$  symbol will continue to move right to the last digit, which is **M** for meter or **FT** for feet. After that, it will return to the first digit.
- The  $\omin�$  key will move the  $\wedge$  symbol in the opposite direction.

- Pressing the  $\odot$  key will increment the active digit by one.
- Every time the  $\odot$  key is pressed, the active digit is incremented from 0 to 9 and back to 0. The  $\ominus$  key will give the opposite direction.
- If the last digit is selected it is possible to switch between meter **M** and feet **FT** display. Pressing the  $\odot$  or  $\ominus$  key will change between the two formats.
- When the desired value has been set, confirm by pressing the key ENTER INSERT briefly.

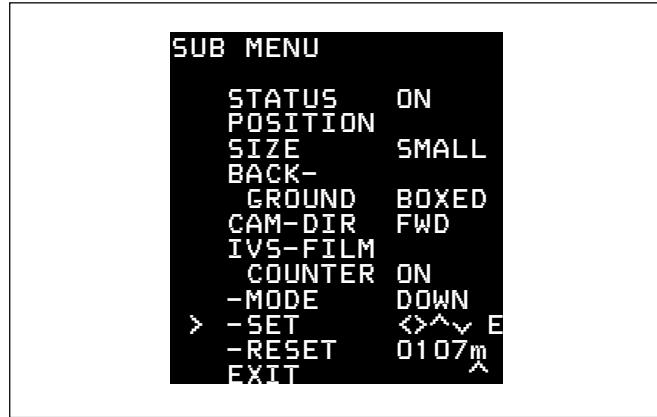

### IVS Film Counter Reset

This sub menu line will reset the IVS film counter to 0000.

- Move the cursor  $\>$  with the keys  $\odot$  and  $\ominus$  to the line **-RESET**. The keys  $\odot$  and  $\ominus$  will reset the counter to zero.

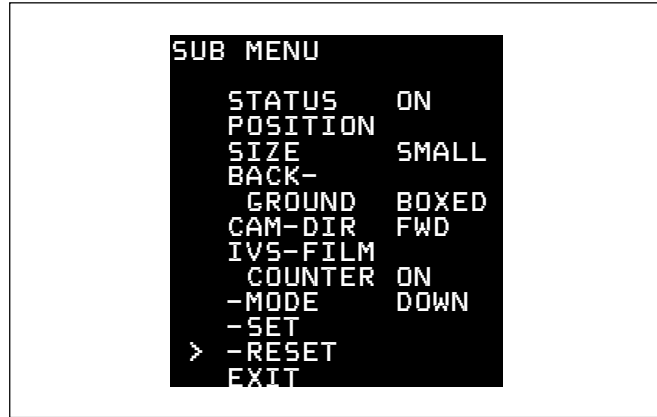

```
SUB MENU
STATUS      ON
POSITION
SIZE        SMALL
BACK-
GROUND      BOXED
CAM-DIR     FWD
IVS-FILM
COUNTER     ON
-MODE       DOWN
-SET
-RESET
> EXIT
```

## 6.4.7 Exit

Return to the main menu using Exit.

- Move the cursor **>** with the keys **▲** and **▼** to the line **EXIT** and press the key **▶** or **◀**.

Note: Pressing the key ENTER INSERT for more than three seconds will cause the system to exit the onscreen programming mode completely, regardless of which menu is activated, with the exception of the positioning mode.

## 6.5 Time Code Menu



*For all TC- and related functions, the ARRIFLEX 535B must be equipped with the data cable ZV4 and the IVS must be in flicker free mode.*

The IVS can insert the film camera's time code into the video assist image to create a direct link to post production.

It is possible to insert time code, which is related to the film camera speed, e.g. 24 fps or a time code which counts according to the type of video assist (25 full video frames per second with PAL or 30 full video frames per second with NTSC).

Like all man-readable information, the data is inserted as a window on the monitor image. The window can be switched on and off independently. Background, position and character format can be altered without affecting the settings of other windows.

The adjustment of the white level of the inserted data, an inverse display and a fine adjustment of the vertical position are described in chapter 6.9

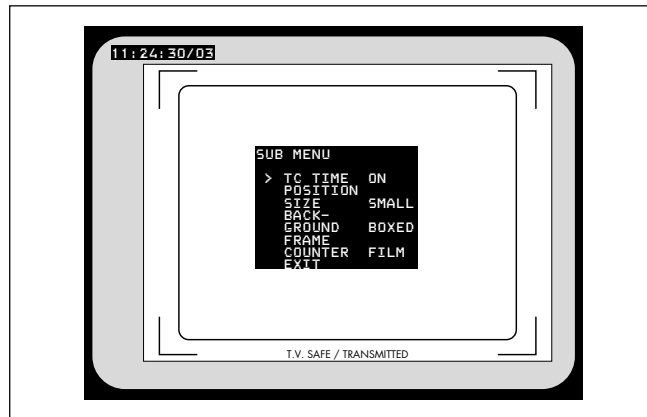

This additional line shows the TC information:

**11:24:30/03**

**Note:** The frame information (the last two digits of the time code display) is only active if time code is actually recorded on film. If there is no time code recording on film because for example the camera is not running on a time code speed, only the symbol \*\* is displayed in that position.

- Enter the **TIME CODE** Menu from the Main Menu.



*All settings are immediately activated by changing them.  
Check all settings on the connected monitor.*

```

SUB MENU
> TC TIME   ON
  POSITION
  SIZE      SMALL
  BACK-
  GROUND    BOXED
  FRAME
  COUNTER   FILM
  EXIT
  
```

```

SUB MENU
  TC TIME   ON
> POSITION
  SIZE      SMALL
  BACK-
  GROUND    BOXED
  FRAME
  COUNTER   FILM
  EXIT
  
```

## 6.5.1 TC Time

This sub menu line switches the insertion of time code data on (**ON**) and off (**OFF**) independently from other inserted data.

- Move the cursor **>** with the keys **▲** and **▼** to the line **TC TIME**. The keys **▶** and **◀** switch the insertion on and off.

## 6.5.2 Position

The window can be positioned anywhere on the monitor screen.

- Move the cursor **>** with the keys **▲** and **▼** to the line **POSITION**. Activate the positioning mode with the keys **▶** or **◀**. The following menu is displayed on the screen:

```
> POSITION◀▶^▼ E
```

- The keys **▶** and **◀** move the window left and right, the keys **▲** and **▼** move the window up and down. When the desired position has been set, confirm by pressing the key **ENTER INSERT**.

### 6.5.3 Size

The format of the inserted characters can be changed independently from other windows from **SMALL** to **WIDE** to **HIGH** to **BIG**.

- Move the cursor  $\blacktriangleright$  with the keys  $\text{\textcircled{A}}$  and  $\text{\textcircled{V}}$  to the line **SIZE**. Pressing the key  $\text{\textcircled{D}}$  will change the setting from **SMALL** to **WIDE** to **HIGH** to **BIG** and back to **SMALL**. The key  $\text{\textcircled{C}}$  will switch in the opposite direction.

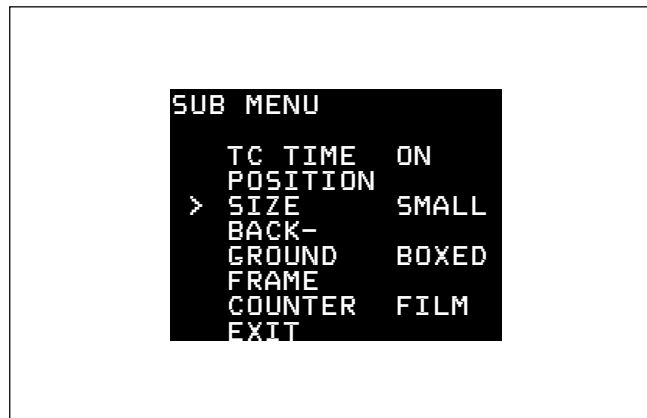

### 6.5.4 Background

The background of the window can be set electronically to black (**BOXED**) to improve readability. If this is not activated, the area around the text is the normal video image (**VIDEO**).

- Move the cursor  $\blacktriangleright$  with the keys  $\text{\textcircled{A}}$  and  $\text{\textcircled{V}}$  to the line **BACK-**. The keys  $\text{\textcircled{D}}$  and  $\text{\textcircled{C}}$  will switch between **BOXED** and **VIDEO**.

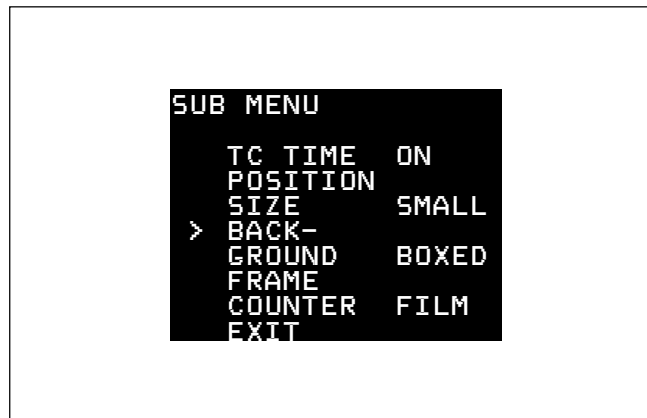

```

SUB MENU
TC TIME    ON
POSITION
SIZE       SMALL
BACK-
GROUND    BOXED
> FRAME
COUNTER   FILM
EXIT
    
```

## 6.5.5 Frame Counter



*It is recommended to check the requirements of all facilities involved in post-production prior to shooting.*

Very often the camera is set to run at a different speed than the video system. In areas with NTSC video system for example, the film camera would run at 24 fps whereas the video system works with 30 full video frames per second. In order to adapt to specific needs there are two different time code formats possible.

To relate the time code count to the film camera, select the mode **FRAME COUNTER FILM**, which is often referred to as "film-related time code". In this mode, the frame counter of the time code (the last two digits of the time code display) is increased by 1 if the film is advanced by one frame e.g. 24 times a second at 24 fps. This makes it easy to identify one particular film frame by looking at the video image. However, this mode will create an unusual time code count because some video images are repeated to cope with the different frame rates of the video and the film camera. These repeated images will get duplicated time code words, which will create error messages on some time code readers.

To relate the time code count to the video system, select the mode **FRAME COUNTER VIDEO**. This is often referred to as "video-related time code". Every full video frame will advance the time code by 1 e.g. 25 times a second in PAL or 30 times a second in NTSC. The IVS now creates a standard time code. However, it is more difficult to get the link back to the time code, which was recorded on film. To get a reliable relation, it is necessary to utilize the Pull-Down (refer to chapter 6.8) or White-Line-Flag information (refer to chapter 6.11).

At every full second, both time counts are identical.



In case of **FRAME COUNTER FILM** there will be a / before the frame count (the last two digits of the time code display), in case of **FRAME COUNTER VIDEO** there will be a ! ⇨ **photo**.



*The frame count is only active if time code is actually recorded on film. In all other cases a \*\* ⇨ **photo** symbol will appear for the count.*



*Time code is only recorded on film at standard speeds. These are 23.976 Fps, 24 Fps, 25 Fps, 29.97 Fps and 30 Fps. At all other speeds, time code is displayed on the video assist without the frame count and it is not recorded on film.*

- Move the cursor ⇨ with the keys Ⓐ and Ⓡ to the line **FRAME**. The keys Ⓢ and Ⓣ switch the frame counter mode between **FILM** and **VIDEO**.

11:24:30/03

11:24:30:03

11:24:30/\*\*

```
SUB MENU
TC TIME   ON
POSITION
SIZE      SMALL
BACK-
GROUND    BOXED
FRAME
COUNTER   FILM
> EXIT
```

## 6.5.6 Exit

Return to the main menu using Exit.

- Move the cursor > with the keys ⬆ and ⬇ to the line EXIT and press the key ⬅ or ⬅.

Note: Pressing the key ENTER INSERT for more than three seconds will cause the system to exit the onscreen programming mode completely, regardless of which menu is activated, with the exception of the positioning mode.

## 6.6 USER BITS Menu



*For all TC- and related functions, the ARRIFLEX 535B must be equipped with the data cable ZV4 and the IVS must be in flicker free mode.*

The IVS can insert the user bits of the film camera's time code into the video assist image to create a direct link to post production.

Like all man-readable information, the data is inserted as a window on the monitor image. The window can be switched on and off independently. Background, position and character format can be altered without affecting the settings of other windows.

The adjustment of the white level of the inserted data, an inverse display and a fine adjustment of the vertical position are described in chapter 6.9

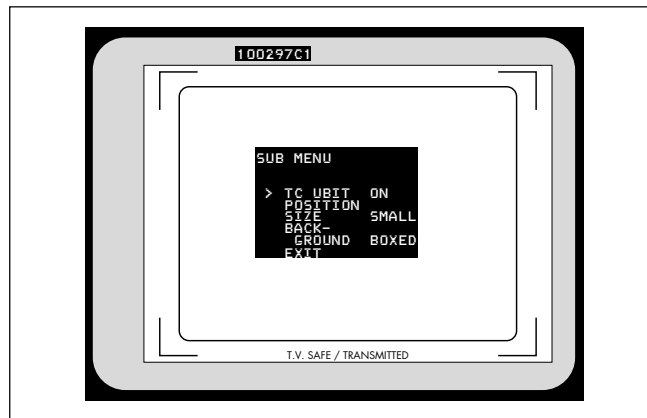

This additional line shows the TC information:

**100297C1**

- Enter the **TC USER BITS** menu from the main menu.



*All settings are immediately activated by changing them.  
Check all settings on the connected monitor.*

```

SUB MENU
> TC UBIT   ON
  POSITION
  SIZE      SMALL
  BACK-
  GROUND    BOXED
  EXIT
    
```

## 6.6.1 TC UBit

This sub menu line switches the insertion of user bit data on (**ON**) and off (**OFF**) independently from other inserted data.

- Move the cursor **>** with the keys **▲** and **▼** to the line **TC UBIT**. The keys **▶** and **◀** switch the insertion on and off.

## 6.6.2 Position

The window can be positioned anywhere on the monitor screen.

```

SUB MENU
  TC UBIT   ON
> POSITION
  SIZE      SMALL
  BACK-
  GROUND    BOXED
  EXIT
    
```

- Move the cursor **>** with the keys **▲** and **▼** to the line **POSITION**. Activate the positioning mode with the keys **▶** or **◀**. The following menu is displayed on the screen:

```

> POSITION◀▶^▼ E
    
```

- The keys **◀** and **▶** move the window left and right, the keys **▲** and **▼** move the window up and down. When the desired position has been set, confirm by pressing the key **ENTER INSERT**.

### 6.6.3 Size

The format of the inserted characters can be changed independently from other windows from **SMALL** to **WIDE** to **HIGH** to **BIG**.

- Move the cursor  $\blacktriangleright$  with the keys  $\text{Ⓐ}$  and  $\text{Ⓡ}$  to the line **SIZE**. Pressing the key  $\text{Ⓢ}$  will change the setting from **SMALL** to **WIDE** to **HIGH** to **BIG** and back to **SMALL**. The key  $\text{Ⓣ}$  will switch in the opposite direction.

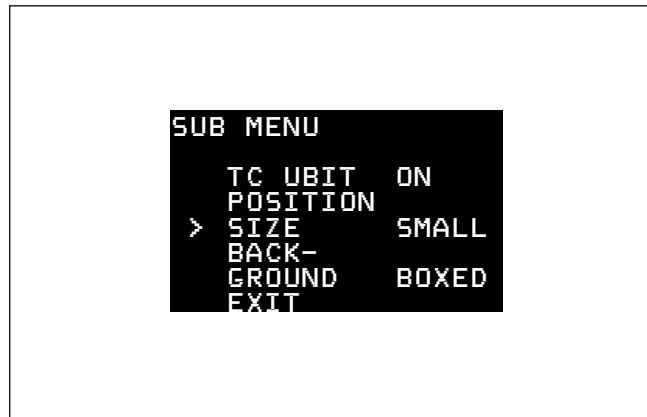

### 6.6.4 Background

The background of the window can be set electronically to black (**BOXED**) to improve readability. If this is not activated, the area around the text is the normal video image (**VIDEO**).

- Move the cursor  $\blacktriangleright$  with the keys  $\text{Ⓐ}$  and  $\text{Ⓡ}$  to the line **BACK-**. The keys  $\text{Ⓢ}$  and  $\text{Ⓣ}$  will switch between **BOXED** and **VIDEO**.

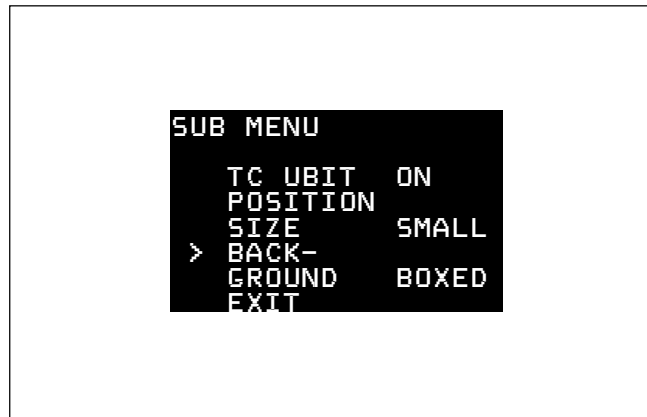

```
SUB MENU
TC UBIT  ON
POSITION
SIZE     SMALL
BACK-
GROUND  BOXED
> EXIT
```

## 6.6.5 Exit

Return to the main menu using Exit.

- Move the cursor  $\rightarrow$  with the keys  $\uparrow$  and  $\downarrow$  to the line **EXIT** and press the key  $\rightarrow$  or  $\leftarrow$ .

Note: Pressing the key ENTER INSERT for more than three seconds will cause the system to exit the onscreen programming mode completely, regardless of which menu is activated, with the exception of the positioning mode.

## 6.7 Text Menu

The IVS can insert additional text into the video image, for example the production name or a scene number. As there is no text input possibility on the camera or on the IVS, it is necessary to enter that text on a computer and to send it to the IVS via the RS 232 interface into the CCU connector of the data cable ZV4.

The latest versions of the Laptop Camera Controller provide corresponding possibilities.

If information is stored in the text memory, it will remain there until the memory is cleared or new information overrides the old one, even if the IVS or the camera is switched off or disconnected from the power supply. This enables for example a camera rental house to store information which is then available to the production team. This might for example be the production name.

Like all man-readable information, the data is inserted as a window on the monitor image. The window can be switched on and off independently. Background, position and character format can be altered without affecting the settings of other windows.

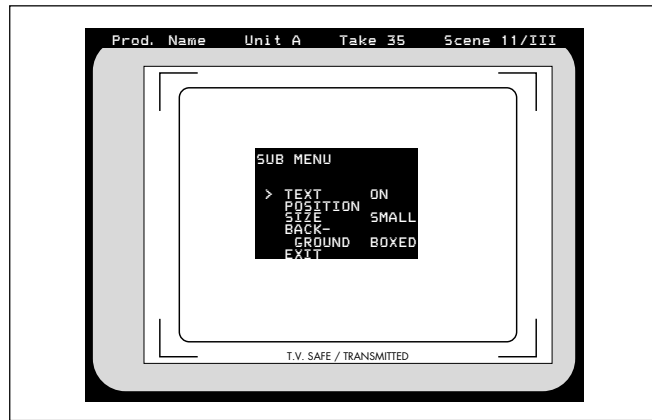

This additional line shows an example of the text information:



The adjustment of the white level of the inserted data, an inverse display and a fine adjustment of the vertical position are described in chapter 6.9

- Enter the **TEXT** Menu from the Main Menu.



*All settings are immediately activated by changing them.  
Check all settings on the connected monitor.*

```

SUB MENU
> Text      ON
  POSITION
  SIZE      SMALL
  BACK-
  GROUND    BOXED
  Exit
  
```

```

SUB MENU
  Text      ON
  > POSITION
  SIZE      SMALL
  BACK-
  GROUND    BOXED
  Exit
  
```

## 6.7.1 Text

This sub menu line switches the insertion of additional text on (**ON**) and off (**OFF**) independently from other inserted data.

- Move the cursor **>** with the keys **▲** and **▼** to the line **TEXT**. The keys **▶** and **◀** switch the insertion on and off.

## 6.7.2 Position

The window can be positioned anywhere on the monitor screen.

- Move the cursor **>** with the keys **▲** and **▼** to the line **POSITION**. Activate the positioning mode with the keys **▶** or **◀**. The following menu is displayed on the screen:

```
> POSITION ^ v E
```

- The keys **▲** and **▼** move the window up and down. When the desired position has been set, confirm by pressing the key **ENTER INSERT**.



### 6.7.3 Size

The format of the inserted characters can be changed independently of other windows from **SMALL** to **WIDE** to **HIGH** to **BIG**.

- Move the cursor  $\blacktriangleright$  with the keys  $\text{\textcircled{A}}$  and  $\text{\textcircled{V}}$  to the line **SIZE**. Pressing the key  $\text{\textcircled{D}}$  will change the setting from **SMALL** to **WIDE** to **HIGH** to **BIG** and back to **SMALL**. The key  $\text{\textcircled{C}}$  will switch in the opposite direction.

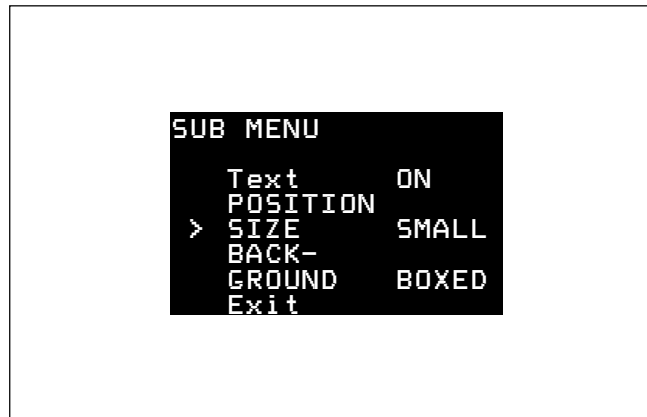

### 6.7.4 Background

The background of the window can be set electronically to black (**BOXED**) to improve readability. If this is not activated, the area around the text is the normal video image (**VIDEO**).

- Move the cursor  $\blacktriangleright$  with the keys  $\text{\textcircled{A}}$  and  $\text{\textcircled{V}}$  to the line **BACK-**. The keys  $\text{\textcircled{D}}$  and  $\text{\textcircled{C}}$  will switch between **BOXED** and **VIDEO**.

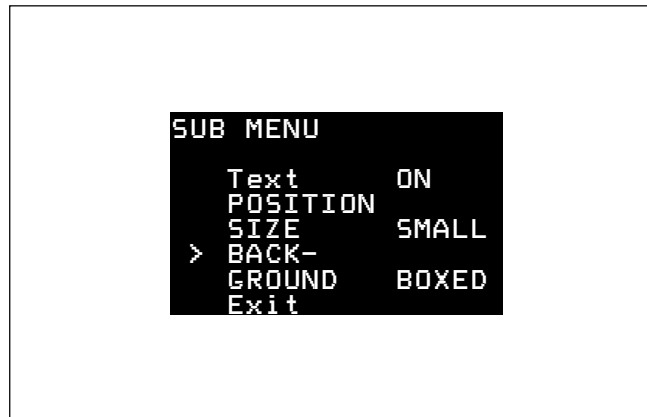

```
SUB MENU
  Text      ON
  POSITION
  SIZE      SMALL
  BACK-
  GROUND    BOXED
  > Exit
```

## 6.7.5 Exit

Return to the main menu using Exit.

- Move the cursor > with the keys ⬆ and ⬇ to the line EXIT and press the key ⬇ or ⬆.

Note: Pressing the key ENTER INSERT for more than three seconds will cause the system to exit the onscreen programming mode completely, regardless of which menu is activated, with the exception of the positioning mode.

## 6.8 Pull-Down Menu



*For all TC- and related functions, the ARRIFLEX 535B must be equipped with the data cable ZV4.*

*The pull-down information is only available when the flicker reduction is switched on.*

The IVS can generate information on whether the current video image corresponds to a new film frame or whether it is a repeated video image. The Pull-Down information displays that in man-readable form.

The adjustment of the white level of the inserted data, an inverse display and a fine adjustment of the vertical position are described in chapter 6.9

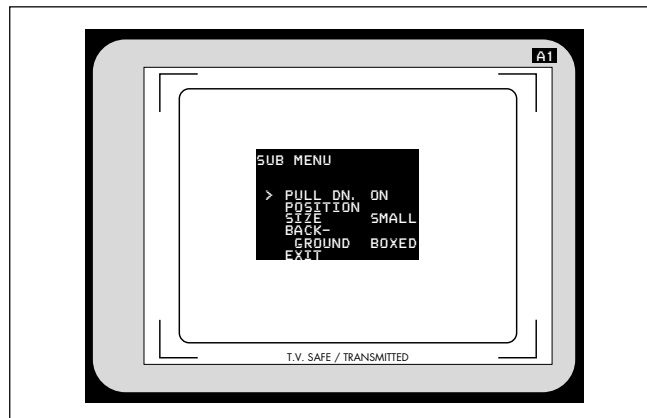

This additional window shows the pull-down information:

**A1**

- Enter the **PULL-DOWN** Menu from the Main Menu.



*All settings are immediately activated by changing them.  
Check all settings on the connected monitor.*

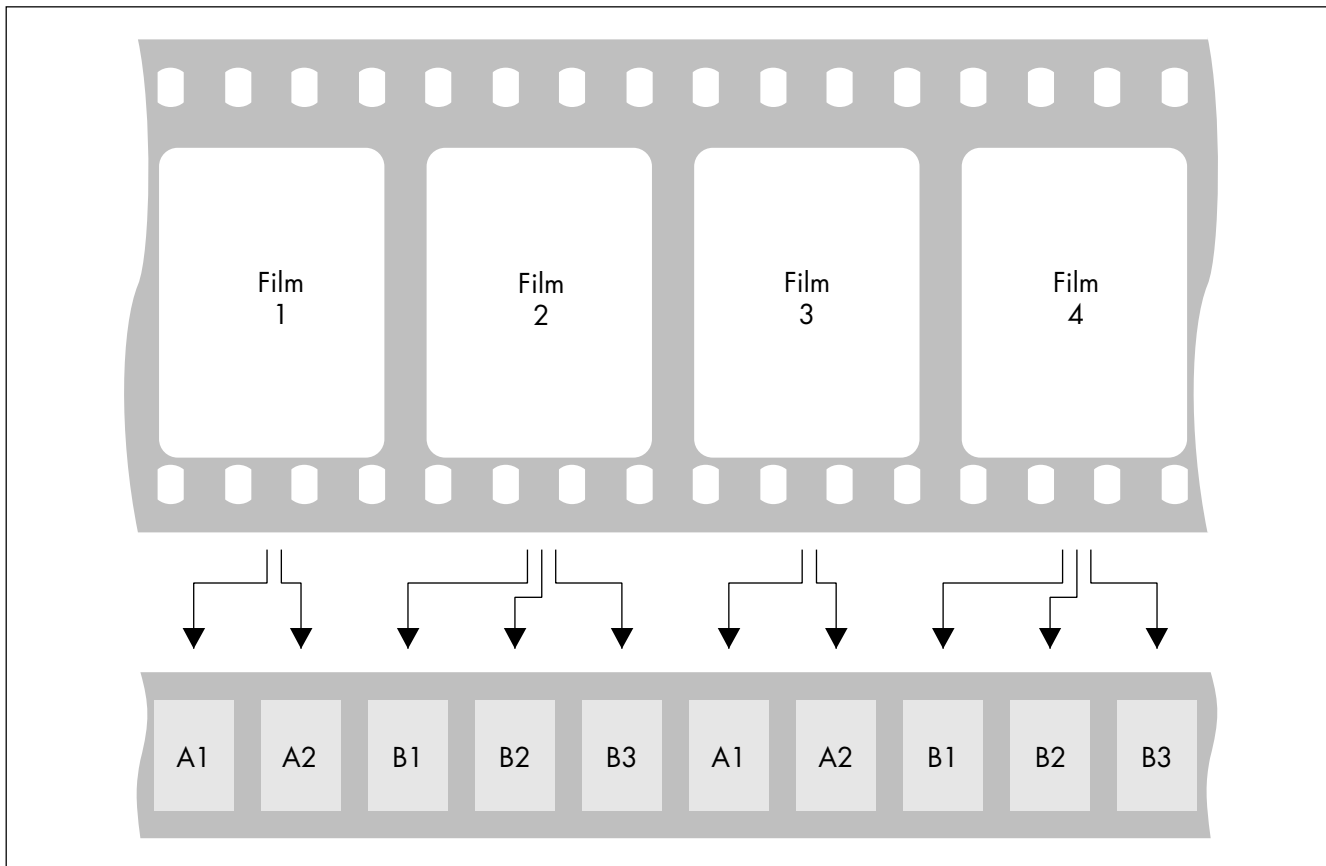

All video assists are based either on PAL or NTSC video systems, with a fixed video frequency of either 25 full video frames per second with PAL or 29.97 full video frames per second with NTSC. The speed of the film camera can however be selected over a wide range. At every film speed which is different from the video frequency, the IVS has to add repeated video fields to compensate for the different frame rates.

In practice the most important case is a film camera speed of 23.976 fps and a NTSC video assist.

This creates the situation described in the drawing.

From the first film frame two video fields are derived, from the second film frame three video fields are derived, from the next film frame two video fields, and so on.

The Pull-Down information is created as follows:

Every time the video field corresponds to a **new** film frame, the letter will change either from A to B or B to A and the number will be set to 1. As long as no new film frame is taken, the video fields are counted, beginning from 1. Consequently A2 is the first repetition of A1. B2 would be the first repetition of B1, B3 would be the second repetition.

In spite of the fact that the name Pull-Down comes from the working practice in the NTSC systems, where on a telecine the film is running on 23.976 fps and gets converted to 29.97 fps, the definition of Pull-Down information on the IVS can also be applied to PAL and to film speeds other than 23.976 fps.

Like all man-readable information, the data is inserted as a window on the monitor image. The window can be switched on and off independently. Background, position and character format can be altered without affecting the settings of other windows.

**Note:** Pull-Down information is only inserted when time code is actually recorded on film. If there is no time code recording, for example because the camera is not running on a time code speed, only A1 will be displayed.

```

SUB MENU
> PULL DN. ON
  POSITION
  SIZE      SMALL
  BACK-
  GROUND   BOXED
  EXIT
    
```

```

SUB MENU
  PULL DN. ON
> POSITION
  SIZE      SMALL
  BACK-
  GROUND   BOXED
  EXIT
    
```

## 6.8.1 Pull-Down

This sub menu line switches the insertion of pull-down information on (**ON**) and off (**OFF**) independently from other inserted data.

- Move the cursor **>** with the keys **▲** and **▼** to the line **PULL DN.**. The keys **⊖** and **⊕** switch the insertion on and off.

## 6.8.2 Position

The window can be positioned anywhere on the monitor screen.

- Move the cursor **>** with the keys **▲** and **▼** to the line **POSITION**. Activate the positioning mode with the keys **⊖** or **⊕**. The following menu is displayed on the screen:

```

> POSITION<^v E
    
```

- The keys **⊖** and **⊕** move the window left and right, the keys **▲** and **▼** move the window up and down. When the desired position has been set, confirm by pressing the key **ENTER INSERT**.

### 6.8.3 Size

The format of the inserted characters can be changed independently from other windows from **SMALL** to **WIDE** to **HIGH** to **BIG**.

- Move the cursor  $\triangleright$  with the keys  $\odot$  and  $\oplus$  to the line **SIZE**. Pressing the key  $\ominus$  will change the setting from **SMALL** to **WIDE** to **HIGH** to **BIG** and back to **SMALL**.  
The key  $\omin�$  will switch in the opposite direction.

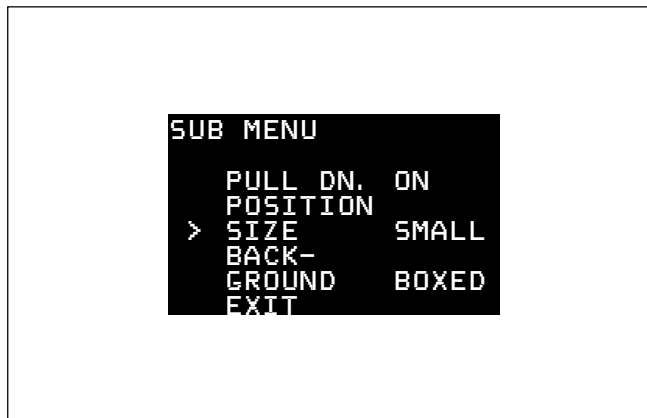

### 6.8.4 Background

The background of the window can be set electronically to black (**BOXED**) to improve readability. If this is not activated, the area around the text is the normal video image (**VIDEO**).

- Move the cursor  $\triangleright$  with the keys  $\odot$  and  $\oplus$  to the line **BACK-**. The keys  $\ominus$  and  $\omin�$  will switch between **BOXED** and **VIDEO**.

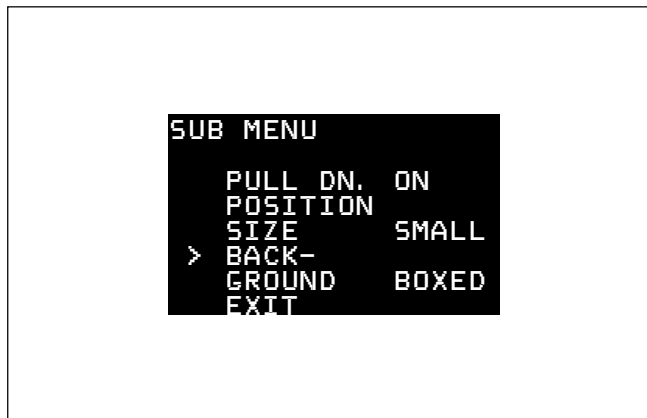

```
SUB MENU
PULL DN. ON
POSITION
SIZE SMALL
BACK-
GROUND BOXED
> EXIT
```

## 6.8.5 Exit

Return to the main menu using Exit.

- Move the cursor  $\rightarrow$  with the keys  $\uparrow$  and  $\downarrow$  to the line **EXIT** and press the key  $\rightarrow$  or  $\leftarrow$ .

Note: Pressing the key ENTER INSERT for more than three seconds will cause the system to exit the onscreen programming mode completely, regardless of which menu is activated, with the exception of the positioning mode.



## 6.9 Display Menu

In the sub menu **DISPLAY** it is possible to change some basic settings, which affect all active man-readable windows of the inserter at the same time.

- Enter the **DISPLAY** Menu from the Main Menu.



*All settings are immediately activated by changing them.  
Check all settings on the connected monitor.*

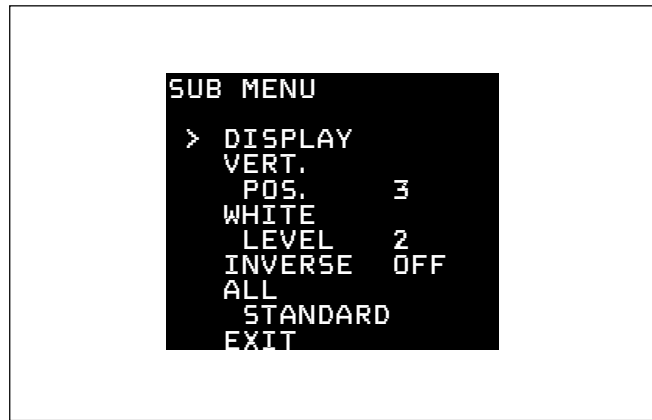

```
SUB MENU
  DISPLAY
  > VERT.      3
    POS.
  WHITE
    LEVEL    2
  INVERSE  OFF
  ALL
  STANDARD
  EXIT
```

## 6.9.1 Vertical Position

By changing the setting in the line **VERTICAL POSITION** of this sub menu it is possible to simultaneously shift all man-readable windows with the exception of the format markings vertically by one video line (fine-tune). The individual steps are smaller than the steps in the normal position mode. This will place all windows as far outside the actual image area as possible.

- Move the cursor **>** with the keys **⬆** and **⬇** to the line **VERT.** . By pressing the key **⬇** the value will increment starting from **0** to **9**, after that it will go back to **0**. Higher values will cause the windows to be at a higher video line. They will therefore appear lower on the video screen. The key **⬆** will decrement in the opposite direction.

## 6.9.2 White Level

This line is used to change the brightness of all man-readable windows except the frame lines. Value 0 means dark gray, value 4 corresponds to bright white characters.

- Move the cursor  $\rightarrow$  with the keys  $\uparrow$  and  $\downarrow$  to the line **WHITE**. By pressing the key  $\leftarrow$  the values for the brightness of the characters will increment beginning from 0 to 4, and after that back to 0. The key  $\rightarrow$  will decrement in the opposite direction.

```
SUB MENU
      DISPLAY
      VERT.
      POS.      3
> WHITE
      LEVEL    2
      INVERSE  OFF
      ALL
      STANDARD
      EXIT
```

## 6.9.3 Inverse

This menu changes the appearance of all man-readable windows except the format markings. If inverse **OFF** is selected, the characters will appear white. If the background is **BOXED** it will appear black. If inverse **ON** is selected, the characters will appear black. If the background is **BOXED** it will appear white.

- Move the cursor  $\rightarrow$  with the keys  $\uparrow$  and  $\downarrow$  to the line **INVERSE**. The keys  $\leftarrow$  or  $\rightarrow$  will switch between **ON** and **OFF**.

```
SUB MENU
      DISPLAY
      VERT.
      POS.      3
      WHITE
      LEVEL    2
> INVERSE  OFF
      ALL
      STANDARD
      EXIT
```

```

SUB MENU
  DISPLAY
  VERT.
  POS.      3
  WHITE
  LEVEL    2
  INVERSE  OFF
> ALL
  STANDARD
  EXIT
  
```

## 6.9.4 All Standard

This menu recalls a default setting of all inserter values. It is thereby possible to obtain basic settings for the IVS.

The default values are:

- Format marking 1, White Level 2, Outside Full
  - Time-Code ON, Size Big, Background Boxed, Counter Film
  - USER-BITS On, Size Big, Background Boxed
  - Status On, Size Small, Background Boxed, IVS film counter OFF
  - Text Off, Size Small, Background Boxed
  - Pull down OFF, Size Big, Background Boxed
  - Vertical Position 5, White Level 2, Inverse OF
  - VITC On, Position 1 - 10, Position 2 - 12
  - White Line On, Position 11
- Move the cursor > with the keys ⬆ and ⬇ to the line **ALL**. Pressing the key ⬅ or ⬆ recalls the default values.

If the **ALL STANDARD** function was called, it is possible to immediately recall the values, that were set before the **ALL STANDARD** function was called.



*The prior settings can not be recalled after the display menu has been left, and no **ALL STANDARD UNDO** function is available until **ALL STANDARD** is called again.*

After calling the **ALL STANDARD** function, the display changes to **ALL STANDARD UNDO**. If this new function is called, the old settings will return.

```
> ALL
  STANDARD UNDO
```

- Move the cursor **>** with the keys **⬆** and **⬇** to the line **ALL**. Pressing the key **⬅** or **⬆** now recalls the old values.



```
SUB MENU
  DISPLAY
  VERT.
  POS.      3
  WHITE
  LEVEL     2
  INVERSE   OFF
  ALL
  STANDARD
  > EXIT
```

## 6.9.5 Exit

Return to the main menu using Exit.

- Move the cursor > with the keys ⬆ and ⬇ to the line **EXIT** and press the key ⏎ or ⬅.

Note: Pressing the key ENTER INSERT for more than three seconds will cause the system to exit the onscreen programming mode completely, regardless of which menu is activated, with the exception of the positioning mode.

## 6.10 VITC Line Menu



*For all TC- and related functions, the ARRIFLEX 535B must be equipped with the data cable ZV4 and the IVS must be in flicker free mode.*

The IVS can convert time code, which can also be displayed man-readable in the video image, into machine-readable VITC (Vertical Interval Time-Code) and place it in non-visible video lines.

**Note:** The time code count that is used ("filmrelated" or "videorelated time code") depends on the settings of the line "Frame Counter" in the sub menu "Time Code" (see chapter 6.5.5).

**Note:** VITC is only outputted if time code is actually recorded on film. If no time code is recorded on film, for example because the camera is not running at a time code speed, no VITC is available.

**Note:** The White Line has priority over VITC lines. If the same line is selected for White Line as well as for VITC, White Line will appear.

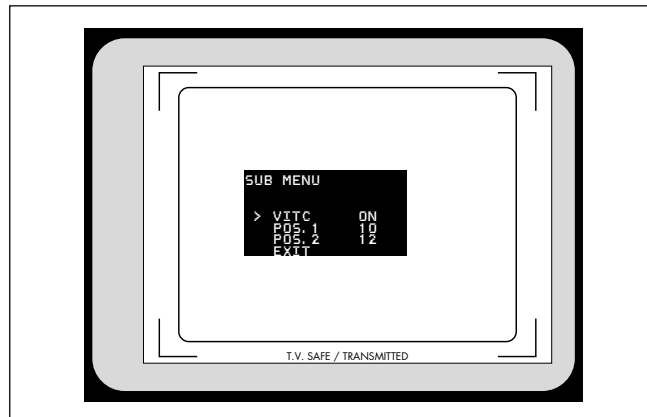

- Enter the **VITC** Line Menu from the Main Menu.



*All settings are immediately activated by changing them.  
Check all settings on the connected monitor.*

```

SUB MENU
> VITC      ON
  POS. 1    10
  POS. 2    12
  EXIT
    
```

## 6.10.1 VITC

This sub menu line switches the insertion of VITC on (**ON**) and off (**OFF**).

- Move the cursor **>** with the keys **▲** and **▼** to the line **VITC**. The keys **▶** and **◀** switch the insertion on and off.

```

SUB MENU
  VITC      ON
> POS. 1    10
  POS. 2    12
  EXIT
    
```

## 6.10.2 Position 1

The insertion of VITC can be single or multiple line between line 6 and 22. If the same lines on position 1 and position 2 are selected, the insertion will be single line, otherwise multiple line. The value of position 1 can be higher or lower than that of position 2.

- Move the cursor **>** with the keys **▲** and **▼** to the line **POS. 1**. By pressing the key **▶** the value will be increased until line **22** is selected. By pressing the key **◀** the value will be decreased until line **6** is reached.



### 6.10.3 Position 2

The insertion of VITC can be single or multiple line between line 6 and 22. If the same lines on position 1 and position 2 are selected, the insertion will be single line, otherwise multiple line. The value of position 1 can be higher or lower than that of position 2.

- Move the cursor > with the keys ⬆ and ⬇ to the line **POS. 2**. By pressing the key ⬇ the value will be increased until line **22** is selected. By pressing the key ⬆ the value will be decreased until line **6** is reached.

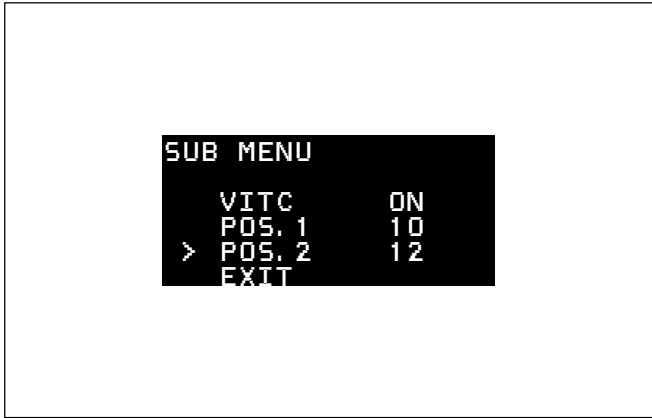

```
SUB MENU
VITC      ON
POS. 1    10
POS. 2    12
> EXIT
```

## 6.10.4 Exit

Return to the main menu using Exit.

- Move the cursor **>** with the keys **⬆** and **⬇** to the line **EXIT** and press the key **⬇** or **⬅**.

Note: Pressing the key ENTER INSERT for more than three seconds will cause the system to exit the onscreen programming mode completely, regardless of which menu is activated, with the exception of the positioning mode.

## 6.11 White Line Menu



*For all TC- and related functions, the ARRIFLEX 535B must be equipped with the data cable ZV4 and the IVS must be in flicker free mode.*

The IVS can generate information on whether the current video image corresponds to a new film frame or whether it is a repeated video image. The White-Line flag displays this in machine readable form.

- Enter the **WHITE LINE** Menu from the Main Menu.



*All settings are immediately activated by changing them.  
Check all settings on the connected monitor.*

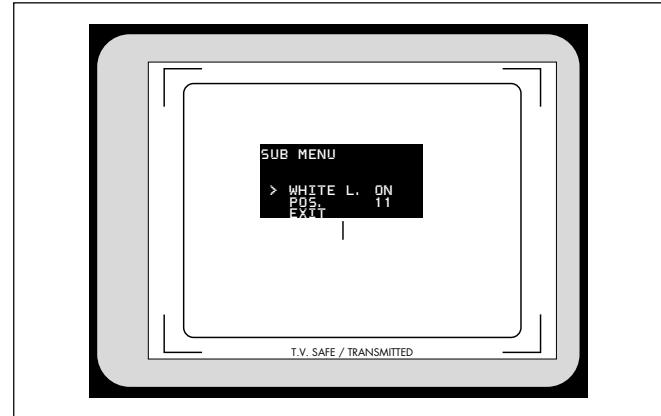

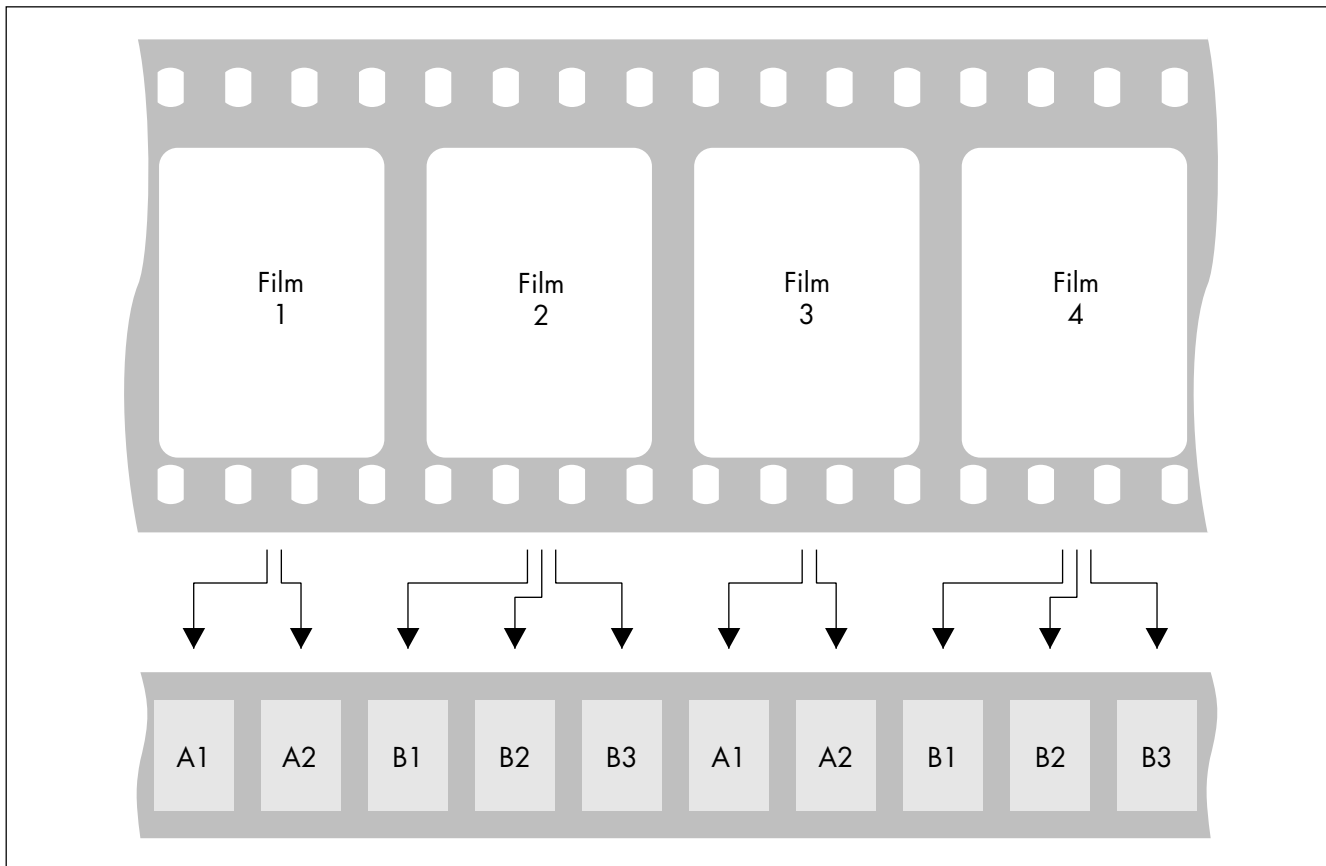

All video assists are based either on PAL or NTSC video systems, with a fixed video frequency of either 25 full video frames per second with PAL or 29.97 full video frames per second with NTSC. The speed of the film camera however can be selected over a wide range. At every film speed which is different from the video frequency, the IVS has to add repeated video fields to compensate for the different frame rates.

In practice the most important case is a film camera speed of 23.976 fps and an NTSC video assist.

This creates the situation described in the drawing.

From the first film frame two video fields are derived, from the second film frame three video fields, are derived, from the next film frame, two video fields and so on.

The White-Line flag works as follows:

Every time the video field corresponds to a **new** film frame, the letter will change either from A to B or B to A and the number will be set to 1. As long as no new film frame is taken, the video fields are counted, beginning from 1. Consequently A2 is the first repetition of A1. B2 would be the first repetition of B1, B3 would be the second repetition. On every A1 or B1, the selected video line will be set to

video signal white, indicating that only these video frames correlate one-to-one to film frames. The duplicated video fields are not marked.

In spite of the fact that the name Pull-Down comes from the working practice in the NTSC systems, where on a telecine the film is running on 23.976 fps and gets converted to 29.97 fps, the definition of Pull-Down information on the IVS can also be applied to PAL and to film speeds other than 23.976 fps.

**Note:** The insertion of White-Line flags is only done when time code is actually recorded on film. If there is no time code recording, for example because the camera is not running on a time code speed, no White-Line flag is sent out.

**Note:** The White Line has priority over VITC lines. If the same line is selected for White Line as well as for VITC, White Line will appear.

```

SUB MENU
> WHITE L. ON
  POS.      11
  EXIT
    
```

## 6.11.1 White Line

This sub menu line switches the insertion of White-Lines on (ON) and off (OFF).

- Move the cursor > with the keys ⬆ and ⬇ to the line **WHITE L.**. The keys ⬅ and ⬅ switch the insertion on and off.

```

SUB MENU
  WHITE L. ON
> POS.      11
  EXIT
    
```

## 6.11.2 Position

The insertion of White-Lines can be between line 6 and 22.

- Move the cursor > with the keys ⬆ and ⬇ to the line **POS.**. By pressing the key ⬅ the value will be increased until line **22** is selected. By pressing the key ⬅ the value will be decreased until line **6** is reached.

## 6.11.3 Exit

Return to the main menu using Exit.

- Move the cursor  $\blacktriangleright$  with the keys  $\text{\textcircled{A}}$  and  $\text{\textcircled{V}}$  to the line **EXIT** and press the key  $\text{\textcircled{D}}$  or  $\text{\textcircled{C}}$ .

Note: Pressing the key ENTER INSERT for more than three seconds will cause the system to exit the onscreen programming mode completely, regardless of which menu is activated, with the exception of the positioning mode.

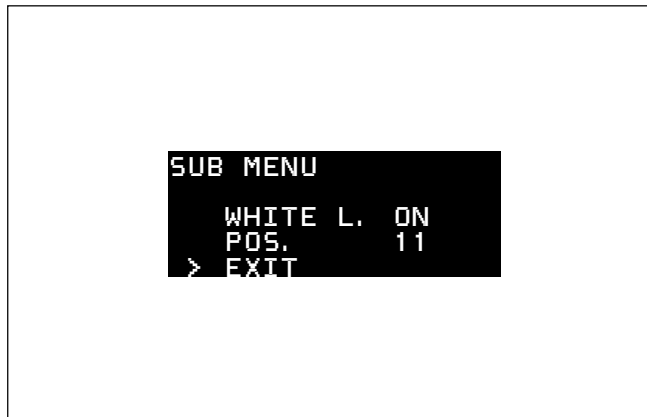

## 7 Technical Data

Weight .....	approx. 1.0 kg
Power Consumption .....	approx. 9 W
Inputs .....	Genlock input for composite video RS 232 Input for data
Outputs .....	2 outputs for composite video 1 output for Y/C video 1 Mini-Monitor Output
Optic .....	2 different versions for Academy and Silent Format
Optic Alignment .....	X-Y, angle and focus

## 8 Order Numbers

Optic Silent and/or .....	K2.47298.0
Optic Academy .....	K2.47301.0
Complete Video Electronic .....	K2.47306.0 for PAL or K2.47307.0 for NTSC



## 9 Index

- A**
- academy format ..... 10
  - academy optic ..... 9, 10, 96
  - accessories ..... 9
  - active digit ..... 58
  - adapters BNC to Y/C ..... 28
  - aligning the video output ..... 20
  - alignment screws
    - changing the optic ..... 24
    - general ..... 33
    - inserting the optic ..... 13
  - all standard ..... 84
  - all standard undo ..... 85
  - automatic white balance ..... 35
- B**
- background ..... 54, 63, 69, 73, 79
  - beam splitter ..... 17
    - changing ..... 16
    - general ..... 15, 16
  - black and white ..... 28
  - boxed ..... 54
- C**
- cabeling ..... 19, 27
  - cables
    - data cable ZV4 ..... 9, 11
    - RS cable ..... 11
  - camera direction ..... 55
  - CCD optic module
    - changing the optic ..... 25
    - general ..... 10
    - mounting ..... 18
    - system components ..... 9
  - CCU-connector ..... 19, 26
  - changing the optic ..... 23
  - CMP-LED ..... 37
  - compare ..... 37
  - components ..... 9
  - composite video ..... 27, 38
  - composite-key ..... 38

- D**
- data cable ZV4
    - changing the optic ..... 26
    - general ..... 11
    - mounting ..... 19
    - system components ..... 9
  - daylight ..... 35
  - different speed between video and film ..... 64, 77, 93
  - display menu
    - all standard ..... 84
    - exit ..... 86
    - general ..... 81
    - inverse ..... 83
    - vertical position ..... 82
    - white level ..... 83
- E**
- exit ..... 49, 60, 66, 70, 74, 80, 86, 90, 95
- F**
- features ..... 7
  - film low sensitivity ..... 32
  - film related time code ..... 64
  - flicker free
    - general ..... 39
    - on/off ..... 39
  - focus screw
    - changing the optic ..... 24
    - general ..... 34
    - inserting the optic ..... 13
  - focusing ..... 33
  - format ..... 46
  - format markings
    - exit ..... 49
    - general ..... 41, 45
    - on/off ..... 46
    - outside darkening ..... 48
    - position ..... 47
    - white level ..... 48
  - frame counter ..... 64, 87
  - frame counter film ..... 64
  - frame counter video ..... 64
  - frame information ..... 61
  - frame store ..... 37
- G**
- gain control ..... 36
  - general description ..... 7
  - genlock ..... 29
- I**
- image alignment ..... 33
  - image pattern ..... 37

- image position ..... 33
  - important notes ..... 6
  - indoor ..... 35
  - inputs ..... 27, 29
    - genlock ..... 29
    - remote control ..... 30
  - inserter ..... 41
  - inserter/antiflicker module ..... 11
    - changing the optic ..... 25
    - mounting ..... 18
    - system components ..... 9
  - inverse ..... 83
  - iris ..... 32
  - IVS film counter ..... 55
    - general ..... 51, 57, 58
    - mode ..... 57
    - on/off ..... 55
    - reset ..... 59
    - set ..... 58
    - switching between meter and feet ..... 59
  - IVS lock ..... 31
  - IVS on/off ..... 31
- K**
- key
    - color coded keys ..... 43
    - composite ..... 27, 28, 38
    - enter insert ..... 43
    - FR ..... 39
    - MGC ..... 36
    - MM ..... 29
    - mode ..... 37
    - STO ..... 37
    - WB ..... 35
    - Y/C ..... 28
  - keyboard lock ..... 31
- L**
- Laptop Camera Controller ..... 30, 71
  - lock ..... 31
  - low sensitivity film ..... 32
- M**
- machine readable information ..... 41
  - Macintosh ..... 9
  - main features ..... 7
  - main menu ..... 44
  - man readable information ..... 41
  - mechanical iris ..... 32

- menu
  - display ..... 81
  - format markings ..... 45
  - main menu ..... 44
  - pull down ..... 75
  - status ..... 51
  - text ..... 71
  - time code ..... 61
  - user bits ..... 67
  - VITC line ..... 87
  - white line ..... 91
- MGC-key ..... 36
- mini monitor output ..... 29
- mixing CCD optic module and inserter/antiflicker ..... 10
- MM-key ..... 29
- motion effects ..... 32
- mounting ..... 15
  
- N**
- normal video ..... 27, 28, 29, 38
- NTSC ..... 8, 9, 10, 11, 61, 64, 77, 93, 96
  
- O**
- on screen displays
  - general ..... 42
  - settings ..... 42
- on/off ..... 31
  
- optic academy
  - general ..... 10
  - order numbers ..... 96
  - system components ..... 9
- optic inserting ..... 13
- optic silent
  - general ..... 9
  - order numbers ..... 96
  - system components ..... 9
- order numbers ..... 96
- OUT 1 ..... 38
- OUT 2 ..... 38
- outdoor ..... 35
- outputs ..... 27
  - composite ..... 27
  - general ..... 27
  - mini monitor ..... 29
  - Y/C ..... 28
- outside dark ..... 48
  
- P**
- PAL ..... 9, 10, 11, 61, 64, 77, 93, 96
- position ..... 47, 53, 62, 68, 72, 78, 94
- position 1 ..... 88
- position 2 ..... 89
- power consumption ..... 96
- product specifications ..... 6

- pull-down
  - 2/3 ..... 77, 93
  - general ..... 64, 78
  - menu ..... 75
- pull-down information ..... 75, 91
- pull-down menu
  - background ..... 79
  - exit ..... 80
  - position ..... 78
  - pull-down ..... 78
  - size ..... 79
  
- R**
- RCU ..... 30
- release key ..... 16
- remote control ..... 30
- repeated video images ..... 64, 75, 77, 91
- RS 232 interface ..... 71
- RS cable
  - changing the optic ..... 25
  - general ..... 11
  - mounting ..... 19
  - system components ..... 9
  
- S**
- safety specifications ..... 5
- serial data input ..... 30
- setup ..... 13
- silent format ..... 9
- silent optic ..... 9, 96
- size ..... 54, 63, 69, 73, 79
- standard video controls ..... 31
- status menu ..... 51
  - background ..... 54
  - camera direction ..... 55
  - exit ..... 60
  - general ..... 52
  - IVS film counter mode ..... 57
  - IVS film counter on/off ..... 55
  - IVS film counter reset ..... 59
  - IVS film counter set ..... 58
  - position ..... 53
  - size ..... 54
  - status ..... 52
- STO-LED ..... 37
- switching between composite video and Y/C ..... 38
- switching between meter and feet ..... 59
- symbols ..... 6
- system components ..... 9

<b>T</b>		<b>U</b>	
TC time .....	62	undo .....	85
TC UBit .....	68	user bits menu .....	67
technical data .....	96	background .....	69
text menu .....	71, 72	exit .....	70
background .....	73	position .....	68
exit .....	74	size .....	69
position .....	72	TC UBit .....	68
size .....	73	<b>V</b>	
text .....	72	vertical position .....	82
time code		video controls standard .....	31
film related .....	64, 87	video electronic	
recording speeds .....	65	general .....	96
video related .....	64, 87	system components .....	9
time code menu .....	61	video optic exchange .....	23
background .....	63	video output alignment .....	20
exit .....	66	video related time code .....	64
frame counter .....	64	video with data .....	27, 28, 29, 38, 41
position .....	62	viewfinder system .....	16
size .....	63	VITC menu .....	88
TC time .....	62	exit .....	90
tungsten lighting .....	35	general .....	87
		position 1 .....	88
		position 2 .....	89
		VITC .....	88

**W**

warnings .....	5
WB-key .....	35
weight .....	96
white balance .....	35
white level .....	48, 83
white line menu .....	94
exit .....	95
general .....	91
position .....	94
white line .....	94
white-line-flag .....	64
Windows .....	9

**Y**

Y/C output .....	28
Y/C video .....	38

**Z**

ZV4 data cable .....	9, 11
----------------------	-------

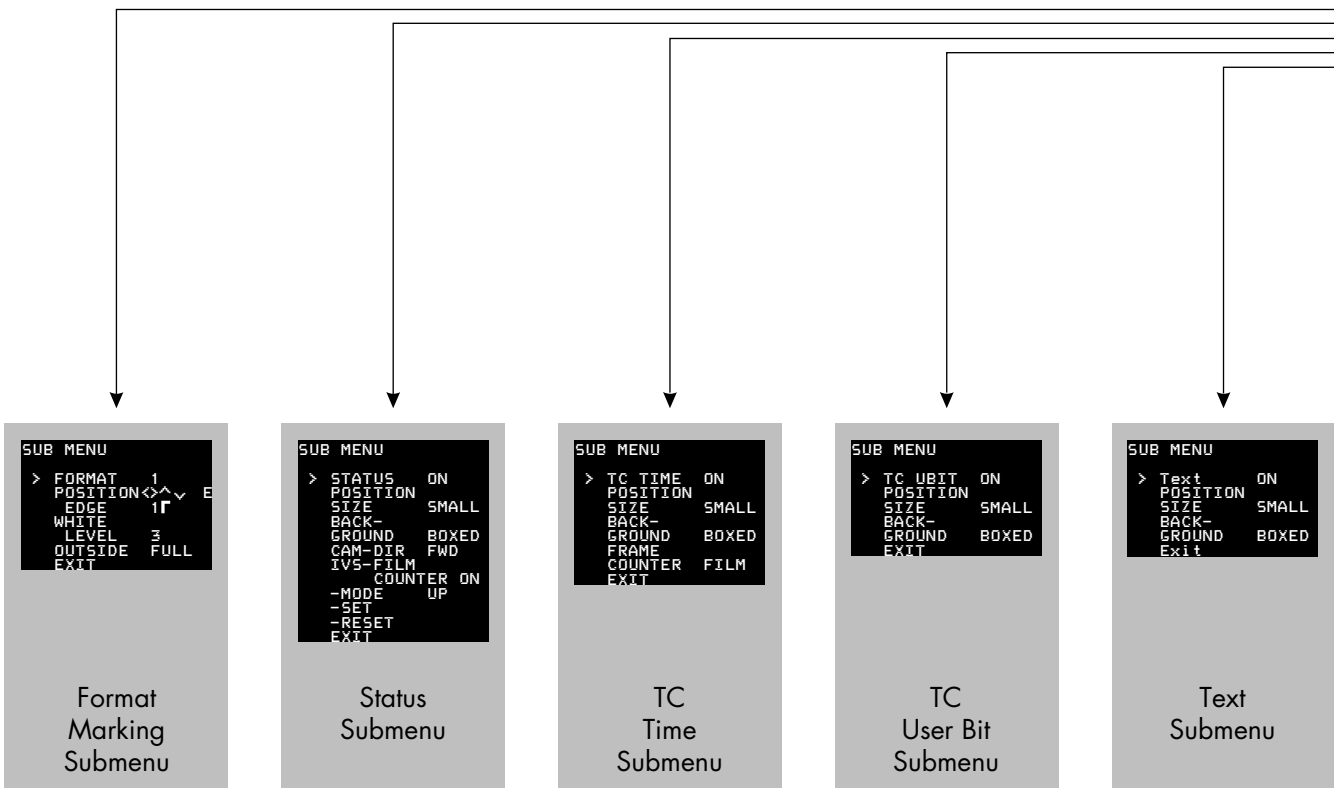



```
MAIN MENU
> FORMAT MARKING
  STATUS
  TC TIME
  TC USER BIT
  TEXT
  PULL DOWN
  DISPLAY
  VITC LINE
  WHITE LINE
```

**Main  
Menu**

```
SUB MENU
> PULL_DN, ON
  POSITION
  SIZE SMALL
  BACK-
  GROUND BOXED
  EXIT
```

Pull  
Down  
Submenu

```
SUB MENU
> DISPLAY
  VERT.
  POS. 3
  WHITE
  LEVEL 2
  INVERSE OFF
  ALL
  STANDARD
  EXIT
```

Display  
Submenu

```
SUB MENU
> VITC ON
  POS. 1 10
  POS. 2 12
  EXIT
```

VITC  
Line  
Submenu

```
SUB MENU
> WHITE L. ON
  POS. 11
  EXIT
```

White  
Line  
Submenu



# ARRI Service

**Germany** ..... Arnold & Richter Cine Technik  
Türkenstraße 89  
D-80799 München  
phone: (089) 3809-0  
fax: (089) 3809-1244  
fax service: (089) 3809-1793  
E-mail service: KDenk@arri.de  
PBentele@arri.de

**USA** ..... ARRI USA  
617, Route 303  
Blauvelt, New York 10913  
phone: (914) 353 14 00  
fax: (914) 425 12 50  
E-mail: arriflex@arri.com

ARRI USA  
600 North Victory Blvd.  
Burbank, California 91502  
phone: (818) 841 70 70  
fax: (818) 848 40 28  
E-mail: arriflex@arri.com

**GB** ..... ARRI (GB) Ltd.  
The Movie House  
1-3 Airlinks, Spitfire Way  
phone: (0181) 848 88 81  
fax: (0181) 561 13 12  
E-mail: sales@arri-gb.com

**Italy** ..... ARRI ITALIA S.R.L.  
Viale Edison 318  
20099 Sesto S. Giovanni (Milano),  
phone: (02) 26 22 71 75  
fax: (02) 242 16 92  
E-mail: info@arri.it

ARRI ITALIA S.R.L.  
Via Placanica, 97  
00040 Morena (Roma)  
phone: (06) 79 89 02 02  
fax: (06) 79 89 02 39

**Canada** ..... ARRI Canada Ltd.  
415 Horner Avenue, Unit 11  
Etobicoke, Ontario  
Canada M8W 4W3  
phone: (416) 255 33 35  
fax: (416) 255 33 99  
E-mail: service@arrican.com

technical data are subject to change without notice

© ARRI 1999

available languages:  
Deutsch K 5.43483.0  
English K 5.43491.0



ARNOLD & RICHTER CINE TECHNIK

---

TÜRKENSTR. 89 • D-80799 MÜNCHEN • TEL. (089) 3809-0  
FAX (089) 3809 - 1244 • <http://www.arri.de>